

W 400 SPRAY GUN



(GB) Before use, adjustment or maintenance, it is important to read this instruction manual very carefully. This manual must be stored in a safe place for any future reference that may be necessary.

This **ANEST IWATA** spray guns kit complies to ATEX regulations 94/9/EC, protection level: II 2 G X Suitable for using Zones 1 and 2.
X marking: Any static electricity discharge from the spray gun is to be diverted to the ground via the conductive air hose as stipulated.



IMPORTANT

This spray gun should be operated only by an adequately trained operator, for safe use and maintenance of the equipment. Any misuse or handling other than those indicated in this Instruction Manual is not covered by guarantee. ANEST IWATA disclaims all responsibility for any accident or damage caused by failure to observe the operational and safety procedures as from this manual. In the interest of user friendliness, this manual contains information in a brief and concise form. For any additional information you may require regarding spray guns operations, or if any missing parts or any damage during transportation is found, please contact your nearest ANEST IWATA Company (see last cover page).

Be sure to observe warnings and cautions in this instruction manual.
If not, it can cause paint ejection and serious bodily injury by drawing organic solvent.
Be sure to observe following marked items which are especially important.

WARNING	Indicates a potentially hazardous situation which, if not avoided, may result in serious injury or loss of life.
CAUTION	Indicates a potentially hazardous situation which, if not avoided, may result in minor or moderate injury or property damage.
IMPORTANT	Indicates notes which we ask you to observe. The safety precautions in this instruction manual are the minimum necessary conditions. Follow national and local regulations regarding fire prevention, electricity and safety as well as your own company regulations.

IMPORTANT SPECIFICATIONS

Max. Pressure:	6.8 bar (98 PSI)	Max. Temperature:	
Noise Level (LAeqT)	79.7 dB (A)	Atmosphere	5 ~ 40 °C
Spray conditions	Recommended	Air and fluid	5 ~ 43 °C
Measuring point	1m backwards from gun, 1,6 m height	Air connection:	G 1/4"
		Fluid connection:	M16x1.5 mm

TECHNICAL SPECIFICATIONS

Model	Nozzle orifice mm (in)	Air cap No.	Air pressure at gun inlet bar (PSI)	Fluid output ml/min	Air consumption l/min (cfm)	Pattern		Weight
						width mm (in)	Spray distance	
High T.E.C. W400 Gravity feed								
W400-082G	0.8 (0.031)	LV2	2.0 (29)	60	280 (9.8)	80 (3.1)	150 (5.9)	380 g
W400-102G	1.0 (0.039)		2.0 (29)	95	280 (9.8)	150 (5.9)	150 (5.9)	
W400-122G	1.2 (0.047)		2.0 (29)	140	280 (9.8)	175 (6.9)	150 (5.9)	
W400-132G	1.3 (0.051)		2.0 (29)	160	280 (9.8)	225 (8.8)	150 (5.9)	
W400-142G	1.4 (0.055)		2.0 (29)	210	280 (9.8)	225 (8.8)	200 (7.9)	
W400-152G	1.5 (0.059)		2.0 (29)	230	280 (9.8)	250 (9.8)	200 (7.9)	
W400-162G	1.6 (0.063)	LV1	2.0 (29)	240	280 (9.8)	270 (10.6)	200 (7.9)	
W400-182G	1.8 (0.071)		2.0 (29)	320	290 (10.2)	260 (10.2)	200 (7.9)	
W400-202G	2.0 (0.079)	R2	3.0 (43)	460	360 (12.7)	320 (12.6)	200 (7.9)	
W400-251G	2.5 (0.098)	W1	3.0 (43)	580	360 (12.7)	340 (13.3)	200 (7.9)	

* Atomizing air pressure means air pressure at gun inlet when trigger is pulled and air flows.

Manufactured by:
ANEST IWATA Corporation 3176,Shinyoshida-cho, Kohoku-ku, Yokohama, 223-8501 Japan

ANEST IWATA Europe S.r.l.
46, Corso Vigevano 10155, Torino Italy
Direct Tel. +39 011 - 24 80 868
Fax +39 011 - 22 74 406
info@anest-iwataeu.com
www.anest-iwataeu.com

ANEST IWATA Italia S.r.l.
46, Corso Vigevano 10155, Torino (Italy)
Tel. diretto +39 011 - 24 80 868 - Fax +39 011 - 85 19 44
info@anest-iwataeu.com www.anest-iwata.it

ANEST IWATA Europe S.r.l.
SUCURSAL ESPAÑA Y PORTUGAL
Avda.del Maresme, 44-46 Planta 2 OF. 25 / 08918 - Badalona
(Barcelona)
Tel.:+34 933 20 59 93 - Fax: +34 933 20 55 64 - info@anest-iwata.es

ANEST IWATA Europe S.r.l.
NIEDERLASSUNG DEUTSCHLAND
Dorfäckerstr. 25, 74248 Ellhofen
Telefon: +49 (0)7134- 917368 - Fax: +49 (0)7134 - 917378
Handy: +49 (0)172 - 62 74 542
f.e.anest-iwata@t-online.de www.anest-iwata.de

European Sales Branches:

ANEST IWATA Scandinavia AB.
Ögärdesvägen 6C, 433 30 PARTILLE
Tel. +46 (0)31 - 340 28 60 - Fax +46 (0)31 - 340 28 69
info@anest-iwata.se www.anest-iwata.se

ANEST IWATA France S.A.
25 rue de Madrid - BP 7405 38074 St Quentin Fallavier
Tél. +33 (0)4 - 74 94 59 69 - Fax +33 (0)4 - 74 94 34 39
info@anest-iwata.fr www.anest-iwata.fr

ANEST IWATA U.K. Ltd.
Unit 10 Little End Road - Eaton Socon
St. Neots - CAMBRIDGESHIRE
PE19 8JH
Tel.: +44 (0) 1480 405419 Fax: +44 (0) 1480 217610
enquiries@anest-iwata.co.uk www.anest-iwata.co.uk

SPARE PARTS LIST

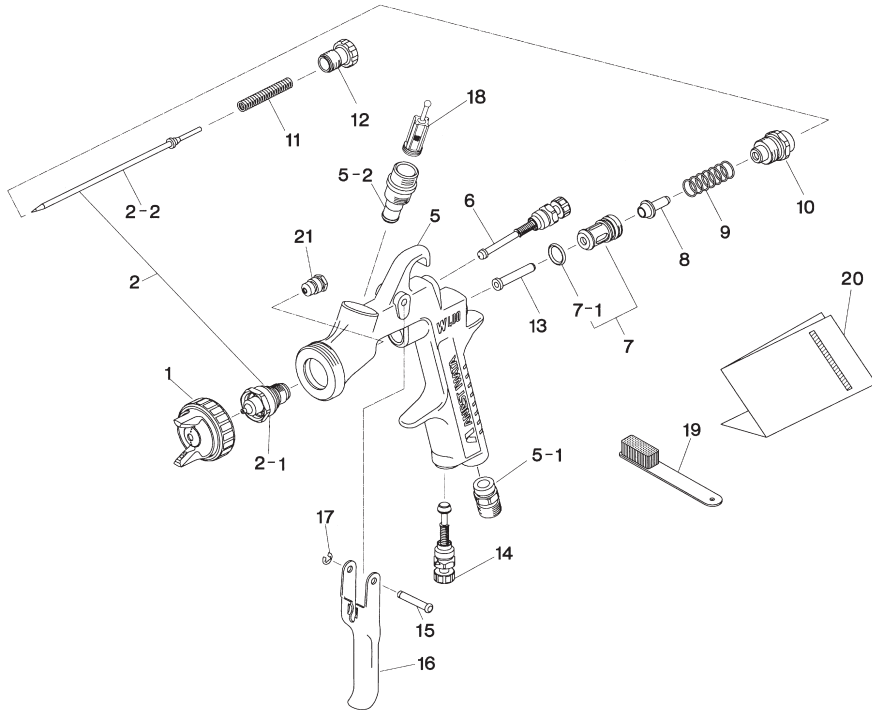

PARTS LIST

DESCRIPTION	REF.PART
AIR CAP SET	1
NOZZLE+ NEEDLE SET	2 ●
FLUID NOZZLE	2-1 ●
FLUID NEEDLE SET	2-2 ●
NEEDLE PACKING CARTRIDGE	21 ●
BODY SET	5
AIR NIPPLE	5-1
FLUID NIPPLE	5-2
PATTERN ADJ. SET	6
AIR VALVE SEAT SET	7
O RING	7-1 ●
AIR VALVE	8 ●
AIR VALVE SPRING	9
FLUID ADJ. GUIDE	10
FLUID NEEDLE SPRING	11
FLUID ADJ. KNOB	12
AIR VALVE SHAFT	13 ●
AIR ADJ. SET	14
TRIGGER STUD	15
TRIGGER	16
E STOPPER	17
PAINT FILTER	18
BRUSH	19
INSTRUCTION MANUAL	20

FLUID NOZZLE-FLUID NEEDLE SET COMBINATION

Fluid nozzle		Fluid needle set
Orifice mm(in)	Mark	Mark
0.8 (0.031)	W200/08	20012H
1.0 (0.039)	W200/10	40012
1.2 (0.047)	W200/12	40012
1.3 (0.051)	W200/13	20015
1.4 (0.055)	W200/14	20015
1.5 (0.059)	W200/15	20015
1.6 (0.063)	W200/16	20015
1.8 (0.071)	W200/18	20018
2.0 (0.079)	W200/20	20020
2.5 (0.098)	W200/25	20025

● Marked parts are wearable parts.

NOTE: When ordering parts, specify gun's model, part name with ref.No. and marked No.of air cap set, fluid nozzle and fluid needle.



OTHER PRECAUTIONS

3. Never spray foods or chemicals through this gun.

If done, it can cause accident by corrosion of fluid passages or adversely affect health by mixed foreign matter.

4. If something goes wrong, immediately stop operation and find the cause. Do not use again until you have solved the problem.

HOW TO CONNECT



CAUTION

- Use clean air filtered through air dryer and air filter. If not, dirty air can cause painting failure.
- When you use this gun for the first time after purchasing, adjust fluid needle packing set. Slowly tighten fluid packing seat and loosen a bit when fluid needle set does not return smoothly, and adjust so that fluid needle set smoothly moves.
- When you use this gun for the first time after purchasing, clean fluid passages spraying thinner and remove rust preventive oil. If not, remaining preventive oil can cause painting failure such as fish eyes.
- Firmly fix cup to spray gun. If not, disconnection and drop of cup can cause bodily injury.

1. Connect an air hose to air nipple tightly.

2. Connect a gravity cup, to fluid nipple tightly.

3. Flush the gun fluid passage with a compatible solvent.

4. Pour paint into container, test spray and adjust fluid output as well as pattern width

HOW TO OPERATE

Suggested air pressure is 2.0 to 3.0 bar (29 to 43 PSI)

Recommended paint viscosity differs according to paint property and painting conditions. 15 to 23 sec. / Ford cup#4 is recommendable.

Keep fluid output as small as possible to the extent that the job will not be hindered. It will lead to better finishing with fine atomization.

Set the spray distance from the gun to the work piece as near as possible within the range of 150_200 mm (5.9_7.9 in).

The gun should be held so that it is perpendicular to the surface of the workpiece at all times. Then, the gun should move in a straight and horizontal line. Arcing the gun causes uneven painting.

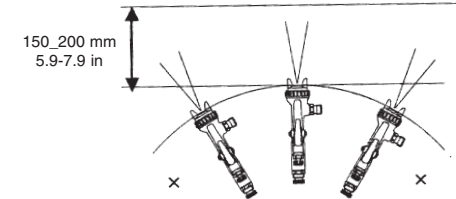

MAINTENANCE AND INSPECTION



WARNING

- First release air and pressure fully according to item No. 3 of "Improper use of equipment" of WARNING on page 2.
- Tip of fluid needle set has a sharp point. Do not touch the tip of needle valve during maintenance for protection of the human body.
- Be careful not to damage the tip of the fluid nozzle or put your hand on it.
- Only an experienced person who is fully conversant with the equipment can do maintenance and inspection.







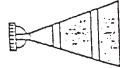

CAUTION

- Never use commercial or other parts instead of ANEST IWATA original spare parts.
- Never immerse the whole gun into liquid such as thinner.
- Never damage holes of air cap fluid nozzle or fluid needle.

Step-by-step procedure	Important
1. Pour remaining paint to another container. Clean fluid passages and air cap set. Spray a small amount of thinner to clean fluid passages.	1. Incomplete cleaning can fail pattern shape and uniform particles. Especially clean fully and promptly after use with two-component paint.
2. Clean each section with brush soaked with thinner and wipe out with waste cloth.	2. Do not immerse the whole gun in thinner. If done, it can damage parts. When cleaning, never scratch any holes of air cap set and fluid nozzle, and fluid needle set.
3. Before disassembly, fully clean fluid passages. (1) Disassemble fluid nozzle. (2) Disassemble fluid needle set. You do not need to remove fluid adj. guide set from gun body. Remove fluid adj. knob and fluid needle spring, and then pull out fluid needle spring, and then pull out fluid needle set from back of fluid adj. guide set.	3. During disassembly, do not scratch seat section. (1) Remove fluid nozzle after removing fluid needle set or while keeping fluid needle pulled, in order to protect seat section. (2) Be careful when handling tip of fluid needle set since it is sharp. Disassemble fluid adj. guide set as little as possible.
4. To adjust fluid needle packing set, while keeping fluid needle set inserted, tighten fluid needle packing seat by hand and then tighten further by spanner.	4. Too much tightening of fluid needle packing set can cause bad movement of fluid needle set and fluid leakage from the tip of fluid needle set.
5. In order to assemble air valve, first assemble air valve & air valve spring & fluid adj. guide set together. Next, insert fluid needle set into fluid adj. guide set, then fit it to gun body set and screw fluid adj. guide set.	5. If you try to fit air valve spring and air valve to gun body set without fluid needle set, air valve will not be fitted correctly and packing inside fluid adj. guide set will be damaged.
6. Turn pattern adj. knob or air adj. knob counterclockwise to fully open. And then tighten pattern adj. set or air adj. set.	6. If pattern adj. knob or air adj. knob are not fully opened, tip of it can contact and damage fluid nozzle and cause seizure of thread.
Where to inspect	Parts replacement standard
1. Each hole passage of air cap and fluid nozzle	Replace if it is crushed or deformed.
2. Packing and O ring	Replace if it is deformed or worn out.
3. Leakage from seat section between fluid nozzle and fluid needle set	Replace them if leakage does not stop after fully cleaning fluid nozzle and fluid needle set. If you replace fluid nozzle or fluid needle set only, fully match them and confirm that there is no leakage.

TROUBLESHOOTING

Spray Pattern	Problems	Remedies
 Fluttering	1. Air enters between fluid nozzle and tapered seat of gun body. 2. Air is drawn from fluid needle packing set 3. Air enters at fluid cup fitting nut.	1. Remove fluid nozzle to clean seat. If it is damaged, replace nozzle. 2. Tighten fluid needle packing. 3. Fully tighten joint section.
 Crescent	1. Paint buildup on air cap partially clogs horn holes. Air pressure from both horns differs.	1. Remove obstructions from horn holes with attached brush. But do not use metal objects to clean horn holes.
 Inclined	1. Paint buildup or damage on fluid nozzle circumference and air cap center. 2. Fluid nozzle is not properly fitted.	1. Remove obstructions. Replace if damaged. 2. Remove fluid nozzle, clean seated section
 Split	1. Paint viscosity too low. 2. Fluid output too high.	1. Add paint to increase viscosity. 2. Tighten fluid adj. knob to reduce fluid output or turn pattern adj. knob clockwise.
 Heavy Center	1. Paint viscosity is too high. 2. Fluid output is too low.	1. Add thinner to reduce viscosity. 2. Turn fluid adj. knob counter-clockwise to increase fluid output.
 Spit	1. Fluid nozzle and fluid needle set are not seated properly. 2. The first-stage travel of trigger (when only air discharges) decreases. 3. Paint buildup inside air cap set.	1. Clean or replace fluid nozzle and fluid needle set. 2. Replace fluid nozzle and fluid needle set. 3. Clean air cap set.

PROBLEMS AND REMEDIES

Problem	Where it occurred	Parts to be checked	Cause	Remedy			
				Tighten	Adjust	Clean	Replace
Air leaks (from tip of air cap)	Air valve set	Air valve	*Dirt or damage on seat			x	x
		Air valve seat set	*Dirt or damage on seat			x	x
		O ring	*Wear on air valve spring				x
Paint leaks	Fluid nozzle	Fluid nozzle - fluid needle set	*Dirt, damage, wear on seat			x	x
			*Loose fluid needle adj. knob		x		
			*Wear on needle spring				x
	Fluid nozzle - gun body	*Insufficient tightening	x				
		*Dirt or damage on seat			x	x	
	Fluid needle - packing set	*Needle does not return due to packing set too tight			x		x
*Needle does not return due to paint buildup on fluid needle					x	x	
Paint does not flow	Fluid needle	Needle packing set, needle set	*Wear	x			x
		Packing seat	*Insufficient tightening	x			
Paint does not flow	Tip of gun	Fluid adj. knob	*Insufficient opening		x		
		Tip hole of nozzle	*Clogged			x	
		Paint filter	*Clogged			x	x