



Static Control

for industrial and cleanroom environments

Meech International manufactures four interrelated product ranges:

- Industrial static and dust control equipment
- Electronics and cleanroom (ESD/ESA) control equipment
- Surface cleaning systems
- Compressed air energy saving and noise reduction products

This brochure covers the Industrial Static Control product range and is intended as an overview only. Further detailed information on Meech product-based solutions and applications can be obtained by contacting any of our offices or distributors or by visiting our web site at www.meech.com.

Contents:

Who is Meech?	3
Meech - a worldwide manufacturing company with offices in the UK, USA, Belgium, Hungary and China.	
What is Static and What Problems Can it Cause?	4
A basic guide to static electricity, its origins and the problems it can cause.	
Detection and Measurement	5
It is vital to understand the location and level of static charge present in a process.	
The Four Technologies	6
Guide to the technologies used by Meech in its static control systems.	
Product Selection Guide	7
Locate the products best suited to solve problems in your industry/application.	
Testing and Measurement	8
Static detection and testing equipment for problem diagnosis.	
Power Supplies	9
High voltage power supplies for AC and Pulsed SC systems.	
Ionising Bars	10
Powerful AC and pulsed DC ionising bars to suit all applications.	
Ionising Tubes	11
Duct ionisers for conveying applications.	
EX Range	12
The Meech EX bars are fully approved and certified to ATEX / UL standards and control static safely in hazardous areas.	
Ionising Blowers	13
Ionising blowers provide powerful, extended range ionisation	
Ionising Air Guns and Nozzles	14/15
Compressed air ionisation for cleaning and product control.	
Static Generation	16/17
Meech static generation systems provide temporary pinning of materials.	
Cleanroom 200 Series	18/19
The Meech Series 200 range of ionisation equipment for the electronics and cleanroom industries.	

Products shown in this document may be covered by one or more patents, patents applied for and/or registered designs and/or trade marks. For further information please refer to our Head Office or visit www.meech.com.



We've got the world covered

Wherever you are in the world, you'll find Meech hard at work, providing a wide range of businesses with specialist expertise. From our headquarters and technical centre in the UK, our manufacturing subsidiary in the USA and sales offices in Belgium, Hungary, China and India, we've got the world covered. In fact, our distribution network now covers 50 countries, providing easy access to fully trained, carefully selected Meech distributors, who can provide in-depth support – wherever you are based.

Outstanding quality as standard

Quality is at the heart of every Meech system. We always work to the highest possible quality standards in everything we do: manufacturing, customer support and technical know-how. Our quality management system is certified by BSI to ISO9001. Products manufactured by Meech are also appropriately certified to international standards which include CENELEC EN 60950, UL/CSA (CUL) and CE. We also hold ATEX and UL“EX” approvals for use in hazardous environments. So, you can be sure you've chosen a solution and a company that will meet your own exacting standards.

All the experience you need

Established in 1907, Meech has earned a worldwide reputation for the design and manufacture of effective, durable systems that are supported by our knowledgeable technical team. With so much to offer, no wonder our global user list has grown to in excess of 7,000 companies, including: Amcor, Avery Dennison, BP, Brückner Group, Ford, GlaxoSmithKline, Honda, Nestlé, Nissan, Procter & Gamble, RPC Group and Tetrapak.

Worldwide Distribution Network



What is Static?

Essentially, a static charge arises when an external force causes electrons to be stripped from an atom leaving it with an excess of protons and a net positive charge. The electrons 'attach' to a recipient atom, which will consequently have an excess of electrons and will be negatively charged.

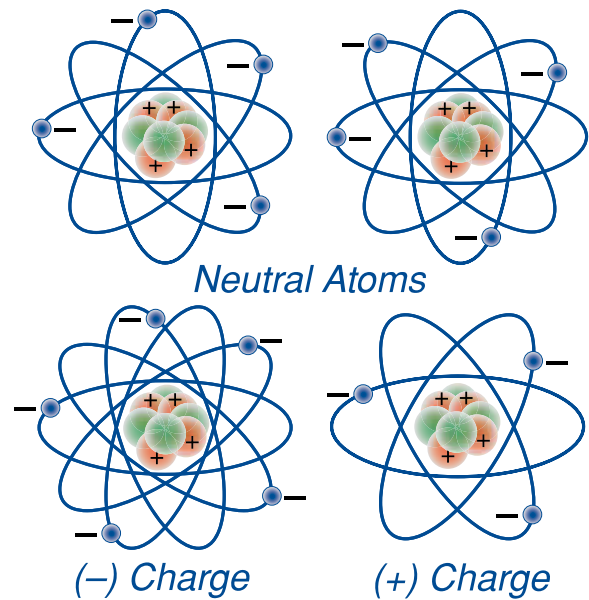

What causes Static?

The most common causes are **Friction**, **Pressure** and **Separation**. Examples range from the unwinding of plastic films to the everyday occurrences of shocks from cars and door knobs. Other causes include **Induction**, whereby an insulator material can become charged if it is brought into an electrical field. **Temperature change** can also generate a static charge; a good example is the generation of static charges on injection mouldings as they cool.

Contact + Pressure + Separation

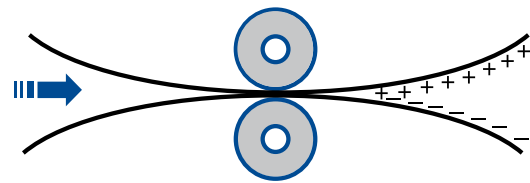

OR



Contact + Friction + Separation

Does this affect all materials?

Electrons can be stripped from practically all atoms by one or more of the above processes. However if it occurs where one of the materials is conductive, that material will not hold the charge (assuming it is grounded), whereas if the material is an insulator (non-conductive) the charge will be unable to move across the surface and literally becomes a static pool of electrical charges.

What other factors are relevant?

The charge **polarity** is not normally an issue. But, it is the **magnitude** of the charge that will cause problems or not. Equally, many items each with a small charge can act as an accumulator to produce a very high static voltage (the "**battery effect**"); an example of this is a container of small plastic parts that have just been moulded. The **force** of any friction, pressure or separation event will directly impact the magnitude of the charge generated, so the higher the input energy, the greater the charge. The **type of material** will dramatically affect the polarity and charge produced. Materials have different electron bond strengths, so some materials will give up electrons relatively easily. This phenomenon is described by the **triboelectric series**. Lastly, the level of ambient **humidity** will play a role in both the magnitude and life of a static charge.

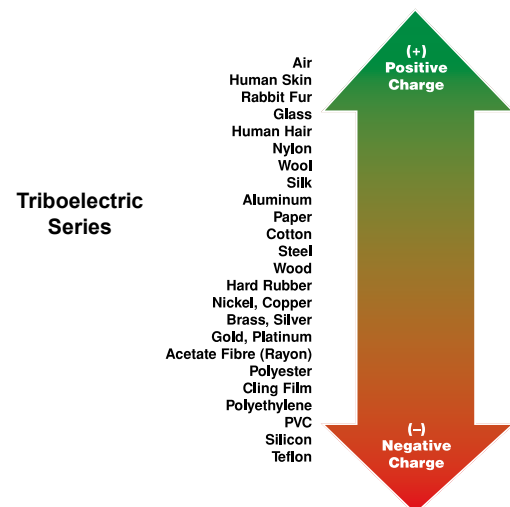

For a more detailed explanation of the topics discussed here, please visit our website at <http://www.meech.com/en/downloads/brochures-booklets> and download 'Static Electricity - Causes and Cures'.

What are the problems?

There are at least 5 major areas where uncontrolled static charges are of concern:

Product misbehaviour

Most commonly used packaging materials are non-conductive. The friction and separation experienced in the processing of such materials generates static charges that can cause blockages in even the most modern machine design. Loss of productivity and profit can result.



Dust attraction

Neutral airborne particles are attracted to charged surfaces and charged particles are attracted to neutral surfaces. The resultant problems can lead to high reject rates, high levels of rework, customer complaints and loss of credibility.



Operator/Personnel shocks

The static voltage that leads to an unpleasant shock when getting out of a car is of the order of 15kV. Yet levels of 20-60kV are commonplace in the plastics and converting industries. Not only are shocks from such charges discomfoting, the recoil effect can lead to more serious accidents.



Fires and explosions

Where a process is carried out in a combustible atmosphere, static charges can have sufficient energy to cause ignition. This can occur where a grounded object intensifies the static field to produce a spark, or where a charge on an isolated conductor (e.g. a non-grounded metal plate) reaches a threshold level and flashes over to a proximity ground. Consequent fires or explosions can result not only in the loss of production time but, in extreme cases, the loss of complete factories!



Electrostatic discharge (ESD)

This is most common in the electronics industry, where a side effect of the drive to smaller scales of circuit is an increase in product sensitivity to static charges. 30 volts is now the common threshold for semiconductors, and hard disk reader heads can be susceptible to charges of less than 3 volts. Problems can arise not only in component assembly but also in later use of the finished product.



AC Static Elimination

A normal mains 110/240V, 50/60Hz AC supply is increased by a special transformer to typically 7kV AC. This high voltage is carried by a shielded HV cable to the static eliminator, where it is connected to an array of emitter pins that are stressed by the elevated voltage in proximity to an earthed surface. This creates a high energy "corona" or "ion cloud", in which a very large number of positive and negative ions are generated. As the AC cycle changes, either positive or negative ions are produced in approximately equal quantities. A statically charged surface of either polarity passing close to this ion cloud will be quickly neutralised.

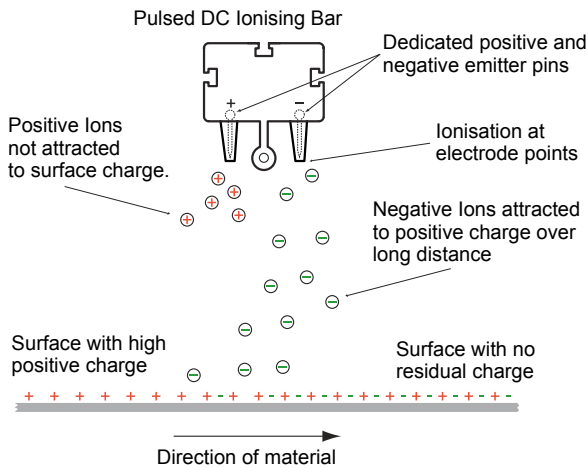
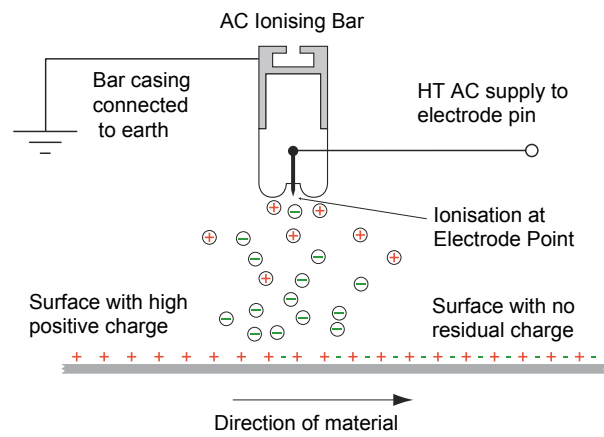

Pulsed DC Static Elimination

Whereas an AC system is limited to generating ions in accordance with the frequency of the AC supply, Pulsed DC technology allows control of not only frequency but also ion balance (the relative proportion of positive and negative ions). Mains voltage is transformed into high voltage that is split into positive and negative outputs and connected to dedicated emitters. Alternating clouds of positive and negative ions are produced in accordance with the chosen frequency setting (between 0.5 and 20Hz). The lower frequencies allow longer distance ionisation to be achieved in still air whilst the balance control allows the ion output to be adjusted to suit the charge polarity on the target. Thus, Pulsed DC systems can offer optimum solutions for specific materials and more demanding applications.

Static Generation

Static Generation describes a method for creating a controlled static charge on a non-conductive material that will allow a sound, but temporary, adhesion between surfaces with charges of opposite polarity. A high DC voltage (up to 50kV) is safely produced and is carried through a HV cable to a static generator bar, where it is connected to an array of suitably designed emitter pins to generate a "corona". The DC voltage may be positive or negative, depending on the application and the characteristics of the materials to be bonded. The emitter pins are positioned within close proximity of a grounded surface (fig.1) or, for greater effect, a generator bar with emitter pins of the opposite polarity (fig.2). The material(s) to be bonded are passed into the "corona", resulting in bonding to the grounded surface or to the other material.

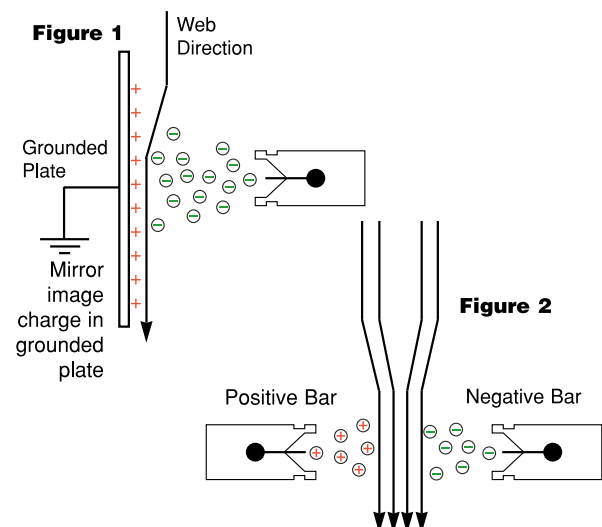



INDUSTRY/APPLICATION	PRODUCT TYPE							
	AC Bars	AC Blowers	AC Nozzles	AC Guns	AC Curtains	Pulsed DC	Static Generation	Series 200
AUTOMOTIVE								
Interior Component Painting/Spray				✓				
Plastic Components Painting/Spray				✓				
Vehicle Body Painting/Spray				✓				
CONVERTING								
Coating	✓	✓				✓		
Laminating	✓	✓		✓		✓	✓	
Plastic Bag (various types)	✓					✓	✓	
Sheeting	✓	✓	✓					
Slitting	✓	✓				✓		
Wind/Rewind	✓	✓				✓	✓	
ELECTRONICS								
Assembly/PC Boards		✓		✓	✓	✓		✓
Bench-top		✓		✓		✓		✓
Cleanroom		✓		✓		✓		✓
PACKAGING								
Blister Packing	✓					✓		
Canning/Bottling			✓		✓	✓		
Form Fill Seal	✓	✓				✓		
Stretch Wrapping	✓					✓		
Wrapping Machines	✓							
PAPER & BOARD								
Corrugated Board	✓					✓		
Paper Production	✓					✓		
PLASTICS - FLEXIBLE								
Blown Film	✓	✓				✓		
Cast Film	✓	✓				✓	✓	
PLASTICS - RIGID								
Blow Moulding					✓	✓		
Extrusion	✓		✓		✓			
GRP		✓		✓				
Injection Moulding		✓	✓		✓	✓	✓	
In-Mould Labelling							✓	
Rotational Moulding				✓				
Thermo/Vacuum Forming		✓		✓		✓		
PRINTING								
Binding/Finishing	✓		✓			✓	✓	
Flexo/Litho Sheet	✓	✓	✓		✓			
Inkjet	✓					✓		
Laser	✓							
On-demand/Digital/Thermal	✓							
Screen	✓	✓	✓	✓	✓	✓		
Tampo	✓		✓			✓		
Web Printing	✓	✓				✓		
TEXTILES								
Beaming/Warping	✓					✓		
Carding	✓					✓		
Folding	✓							
Inspection	✓							
Stenters	✓							

Testing and Measurement

983v2 Static Locator

The Model 983v2 Static Locator provides accurate measurement of static electrical charges. Its design enables fast response, low drift and ease of operation. The wide measurement range of -200kV to +200kV handles all applications.



984v2 Ion Sensor

The Meech Model 984v2 Ion Sensor is an easy-to-use device for checking the performance of both AC and DC powered static eliminator bars. Indicator lights confirm the presence of ions and, in the case of a DC power source, their polarity.



Test Kit - 983v2 & 984v2

The Meech 983v2 & 984v2 test kit gives operators & maintenance staff the ability to diagnose static related issues and monitor the performance of their ionising equipment.



990 Surface Resistance Meter

The 990 SRM measures both surface resistivity and resistance to ground, giving simple repeatable measurements of conductive, static dissipative and insulative surfaces.



Customers opinion:

"We are thrilled with the set up now in place and the money it has saved enables us to deliver the performance solutions we promise our clients on budget, as well as guaranteeing the high quality aesthetics associated with our product."

~ Process Engineer, Viracon, USA

Power Supplies



904/905

Models 904 and 905 are the constant voltage power supplies, designed to provide a 7kV (904) or 5kV (905) source for Meech AC ionizing equipment. They are adjustable to operate at 100-120V or 200-240V input voltage and are available in either 50Hz or 60Hz versions.



977v3

The Model 977v3 Pulsed DC Controller has been designed to operate with the full industrial range of Meech Pulsed DC static elimination equipment. It is light and compact but able to cope with the most technically demanding industrial applications. In addition to the ability to control power output, frequency and polarity, the 977v3 also offers alarm and remote monitoring and control functionality.



977CM

The 977CM – Current Monitoring Pulsed DC Controller, brings together powerful long-range ionisation; closed-loop feedback; self-monitoring and remote reporting. A complete package, unique to Meech. Self-monitoring and adjustment of performance allows optimum control of static for much longer periods than previously possible. Local display and output signals alert operators to the need to clean the equipment.



Feedback System

A feedback system greatly improves the accuracy of the charge removal. A feedback sensor bar can be directly connected to the 977CM. Localised display of balance lets the operator know that the charges are being controlled, whilst a 0-5V signal can be logged for quality purposes.

“Due to the fact static can’t be seen by the naked eye, it is often not considered as a cause of production problems. However, with our operator experience and Meech’s expertise in static control solutions, we quickly identified where improvements could be made. The Meech systems now enable us to run our rewinding machines at twice the previous speed and have eliminated potential quality problems. Time is also saved with the Feedback automatic control system and operators are no longer concerned about the possibility of shocks due to static built up. Everyone from the management to the machine operators are delighted with the results.”

~ Production Manager, Technibond, UK

Ionising Bars

910 Bar

The Model 910 bar incorporates an inductively coupled design that achieves powerful static neutralisation with completely shockproof operation. The design is compact, yet rugged, enough for most industrial applications .

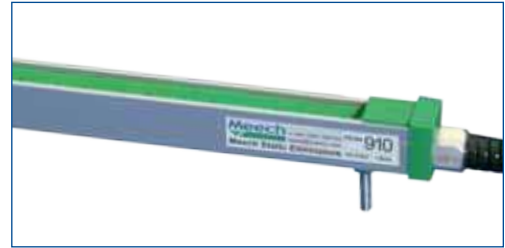

912 Circular Bar

The Model 912 range of circular static eliminators is based on the popular Model 910 shockless bar. The inductively coupled design provides powerful static neutralisation and completely shockproof operation.



914 Bar

The model 914 AC Ionising Bar shares the same resistive coupling of the 915, whilst similar to the 910 in size. It provides an ideal replacement for old style bars and its compact design allows installation on cramped machinery.



915 Bar

The Meech Model 915 AC Bar meets the most demanding of static elimination problems. The powerful performance of the Model 915 provides very fast decay times and effective ionisation up to distances of 150mm. The design of the 915 is such that it can operate for long periods between cleaning.



976 Bar

The Meech Model 976 Pulsed DC Bar is unique and has been designed to provide highly effective long range ionisation up to distances of 600mm. It is shockless and is easily maintained.



Customers opinion:

“The 915 systems worked straight away and have needed no maintenance since installation. We will definitely call on Meech if we have any further static problems.”

~ Maintenance Manager, 4DM, UK

Ionising Tubes

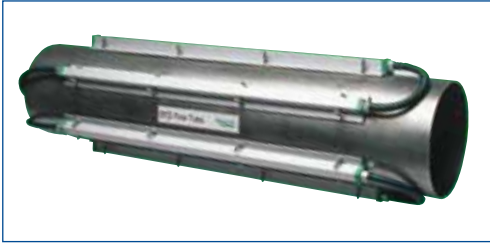

913 Flow Tube

The Meech Model 913 Flow Tube neutralises static charges on materials in handling and conveying systems. The Model 913 Flow Tube incorporates in-line ionisation, which eliminates material clinging and clogging in ducting systems due to static charges. The 913 Flow Tube is available in a range of diameters to suit the specific application.

Options

Inter Connect for 976 Pulsed DC Bars



Installation of pulsed DC bars on wide machinery can be made easier by installing a series of interconnected bars.

Air Assist



The effective range of bars can be increased by the addition of an air-boost system.

Quick Connect for 915 AC Static Bars



On machinery where AC bars need to be disconnected periodically, the quick-connect option provides a simple solution.

Water Resistant



A water resistant option allows the installation of bars where routine machine cleaning can cause them to be splashed.

Dust Proof for 915 AC Static Bars



For installation in dirty or dusty environments the dust proof option improves reliance of the bar.

Replacement Pins for 976 Bar



Replacement pins allow model 976 pulsed DC bars to be kept in as-new condition

900vs2



Monitoring of AC systems provides piece of mind. Clear LED's indicate the state of the HT output.

"We were very impressed with the level of technical information that we received from Meech to ensure optimum operation of the equipment."

~ Design Engineer, Autobond, UK

Ex Range

915Ex Bar

The Meech Model 915Ex is based on the popular 915 AC system. It is classified for use in hazardous environments and is particularly suited to coating, laminating, finishing and gravure printing applications. The 915Ex is certified by Baseefa to comply with Article 9 of the Council Directive 94/9/EC (ATEX). 915Ex bars are also UL approved to Class I, Div 2, Group D hazardous locations.



935Ex Blower

Utilising high-power 915Ex bars and a remote fan unit, the 935Ex provides excellent long-range ionisation. Uses include solvent-based coating heads.

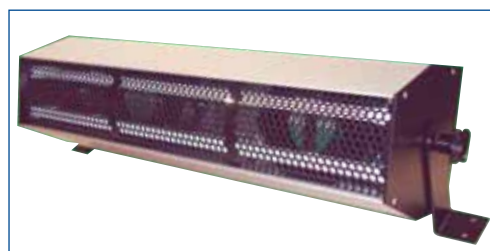

957 Curtain with 915Ex Bar

Model 957Ex consists of a Meech 915Ex static eliminator bar mounted on to Energy Saving Compressed Air Curtain. It produces a high speed, laminar beam of ionised air for long range static neutralisation and dust removal. It is available in a variety of lengths. The 915Ex Bar is BASEEFA (EXs IIA T6 - Zone 1 on 2) and UL approved for use in hazardous areas.

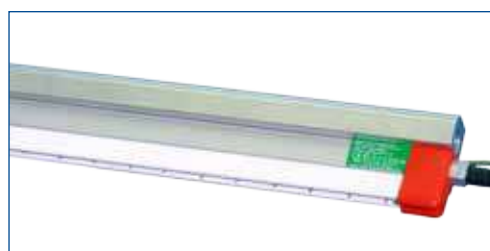

976Ex Bar

The Meech Model 976Ex is unique and has been designed to extend the exceptional performance and other benefits of the 976 Pulsed DC system to classified hazardous environments. It is particularly suited to coating, laminating, finishing and gravure printing applications. The 976Ex is certified by Baseefa to comply with Article 9 of the Council Directive 94/9/EC (ATEX). It is also UL approved to Class I, Div 2, Group D hazardous locations.



Customers opinion:

"ISP Calvert City changed to the Meech 915Ex bar approximately 5 years ago. Since the installation, we have seen a significant decrease in equipment downtime related to static elimination devices. We are pleased with the performance of the bars."

~Senior Reliability Engineer, ISP Chemicals, LLC, USA

Ionising Blowers

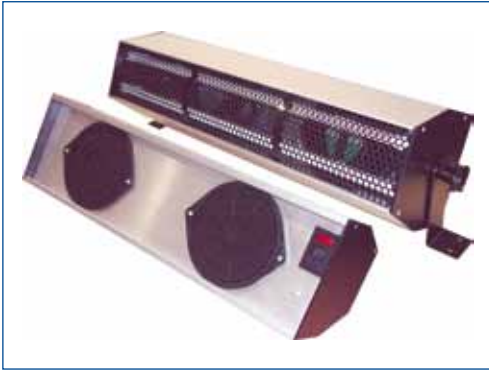

935 Blower

The Model 935 Ionising Blower provides effective long range ionisation over a large area. Its versatility makes it suitable for a wide range of industrial applications. The Model 935 comprises an ionisation head and an integrated fan system. A high volume flow of ionised air is generated by blowing air through the ionisation head at the mouth of the unit.



957 Ionised Air Curtain

The Meech Model 957 Ionising Air Curtain is an extremely versatile unit that provides effective static neutralisation and dust removal in a wide range of industrial applications. The unit comprises a Model 915 bar mounted on to an Energy Saving Compressed Air Curtain, to produce a high speed, laminar beam of ionised air.

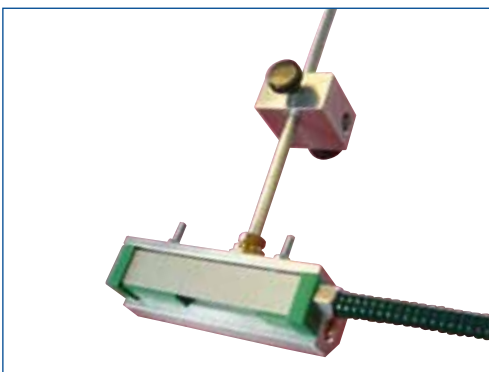

958 Sheet Separator

The Meech Model 958 Sheet Separator system has been designed to allow efficient operation of automatic sheet feeders by eliminating static charges and separating the sheets with a controlled blade of ionised air. The system comprises of one or more full flow Meech ionising air curtains on adjustable brackets, which are mounted on the cross rod of the feeder.

"We have been delighted with all the static solutions that Meech has provided. They have resulted in higher yields and throughput on our contact lens production lines."

~ Production Engineer, Cooper Vision, UK

Ionising Air Guns and Nozzles

954 Gun

The Meech Model 954 is a hand-held ionising air gun used for neutralising static charge and removing dust contamination in a wide range of industrial processes. The ergonomic, lightweight design of the 954 provides simple, quiet and effective operation.



955 Gun

The Meech Model 955 is a hand held ionising blow gun. It is a portable and efficient way of removing static charges and dust in a range of industrial applications. An electrical centrifugal fan provides high velocity air flow, avoiding the need for a costly compressed air supply. The 955 requires just a standard single phase 110V or 240V supply, thereby making the unit fully portable.



940 Nozzle

The Model 940 is available as either a “Through Type” or “Blank End” nozzle. The Through Type nozzle allows the HT cable to pass through so that more than one nozzle can be installed in series on to the cable. It is suitable for applications requiring the removal of electrostatically attracted dust and for longer range static neutralization



942 Nozzle

The Meech Model 942 is a small, lightweight in-line ionising air nozzle with highly efficient air flow characteristics. It can be used either as a single unit (Blank End) or with two or more units connected in series (Through Type). The 942 is designed for use with low pressure air lines. It is particularly suited to applications on sheet feeder and delivery systems.



Customers opinion:

“We were impressed with the prompt service and excellent solution offered by Meech. Although it was originally installed as a temporary measure, it is now always switched on to ensure uninterrupted production in our factory.”

~ Production Director, Moffat Press, UK

Ionising Air Guns and Nozzles



261 Nozzle

Meech's Model 261 Ion Nozzle is a small, lightweight ioniser for use with our range of Pulsed DC Controllers. It is suitable for installation into machinery and equipment used within cleanrooms as well as industrial environments. It is quick to install, using the optional mounting bracket, and easy and safe to use.



261 Slotted Ionising Nozzle

The Slotted 261 Ion Nozzle produces a blade of ionised air. Particularly useful for separating sheets on printer feed-stack. Mounted on adjustable brackets the ionised air breaks the bond between the sheets and prevents double-feeding.



261 Flexi Ionising Nozzle

The Meech Model 261 Flexi Nozzle is a small, lightweight 261 nozzle with the discharge outlet extended by flexible knuckle trunking. It is particularly suited to high speed applications such as sheet delivery systems. The addition of flexible knuckle trunking enables the system to deliver ionized air with accuracy into difficult to reach places, where conventional systems would be ineffective or impossible to install

Options

261 Brackets



Universal mounting brackets simplify installation of 261 nozzles.

Printing on metallised paper can be problematic due to static. However since the installation of the Meech 261 Flexi nozzles on two presses, our press teams have reported a significant improvement in run performance on our metallised stocks. Meech service post installation during the first few weeks of production has been excellent."

~ Production Director, Darley Ltd, UK

Static Generation

992v3 (30kV and 50kV)

The Meech Model 992v3 (30kV and 50kV) Static Generators create a controlled level of static charge to impart temporary bonding between materials, at least one of which is insulative. The 992v3s provide a high voltage output adjustable over the range 0-50kV or a constant current that can be adjusted between 0 and 260µA (50kV) or 0 to 500µA (30kV). The selected output voltage or current is shown on a digital display. The adjustability of the output voltage and current enables the unit to be used in a multitude of applications and with a variety of materials. The 992v3 generators are used in conjunction with the Model 993R sparkfree generator bar or selection of pinning heads and are available in either negative or positive output polarity versions.



993R Generator Bar

The Meech Model 993R is a high performance Generator Bar for use with the Meech range of 30kV and 50kV high voltage DC static generators. Resistively coupled emitter pins deliver smooth, controlled pinning whilst spark free operation avoids tripping out on intermittent applications.



994 Single Point Pinner (SPP)

The 994-SPP system provides individually resistively coupled pinning heads. Splitter blocks with four or six outlets give spark-free pinning; ideal for larger in-mould labelling applications.



994 Hydra (IML)

The Hydra system offers miniaturised pinning heads that can be installed in the smallest of in-mould labelling applications; including drinking cups and food containers. Modular design makes it suitable for both end-users and OEMs.

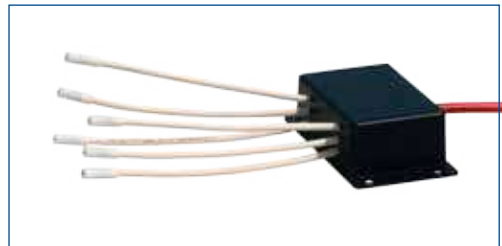

Customers opinion:

“This new solution is a significant improvement on the previous vacuum system that could result in marked products. The Meech engineer understood our requirements and has given us excellent service and support.”
a Model 992v3 static generator and a 994SPP – Single Point Pinning System.

~ Manager, Edart Electronics, China

Static Generation



995 Pinning Heads

With a Compact design in a PTFE body, the 995 series of pinning heads deliver exceptional pinning of multi-layer plastics. Uses include bag making and flow-wrapping machinery.



995 Hand Held Pinner

Manual pinning applications require safe, spark-free operation. The integral switch on the 995 Hand-held pinner allows the operator to switch the system on only when required.



995 Edge Pinning Claw

The 995 Edge Pinning Claw is a powerful pinning head intended for use on cast-film lines. Pinning the edges of the cast film to the chill roller prevents necking of the film. Resistively coupled titanium pins deliver spark free pinning. The 995-CLAW can be powered from either our 30kV or 50kV range of 992v3 generators

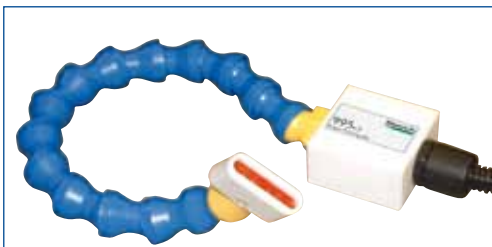

995v3 Flexible Pinning Head

The Model 995v3 Flexible Pinning Head is designed for use with the Meech range of high voltage static generators. Resistively coupled emitter pins deliver smooth, controlled pinning whilst spark-free operation avoids tripping out on intermittent applications. The flexible trunking permits accurate positioning to enable targeted pinning of non-conductive materials.



995 Dirty Environment Pinner

The 995 Dirty Environment Pinner provides electrostatic pinning in applications where the risk of contamination is high.

The resistively-coupled titanium pins are shrouded to offer a physical protection whilst an open design avoids the build up of contaminant. This makes them ideal for food overwrapping machinery where spillages are common.

“Continuing difficulty with our existing static pinning system was causing very low productivity. So, we contacted Meech for an alternate viewpoint. The Meech engineers advised on the use and installation of a Hydra pinning system. We have now achieved consistent performance on our in mould labelling process and much higher productivity.”

~ Managing Director, Shalam UK Ltd, UK

Cleanroom 200 Series

221 and 225 Blower

The Model 225 Ionising Blower provides a high level of ESD protection with excellent workstation coverage, “quiet” operation and ease of maintenance. Standard lengths of 600mm and 1200mm are available to suit the specific application. The 225 is the top-of-the-range Model and is provided with an extensive range of features and options.

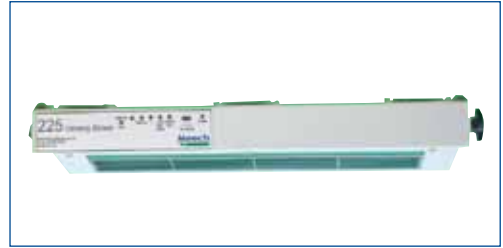

212v2 Blower

The Model 212v2 Bench top Ioniser is a compact unit which complements the Meech Series 200 product range. This model provides excellent work station coverage and a high level of ESD protection. It has been specifically designed to meet the demanding performance requirements in applications such as:

- Semiconductor manufacture
- Electronics assembly & testing
- Test and re-work
- Optics, contact lenses & fibre optics
- Medical device manufacture & packaging
- Wave soldering



233v3 Pulsed DC Controller

The Model 233v3 Pulsed DC Controller has been designed to operate with the Series 200 range of ionisers for ESD applications. The 233v3 is light, compact and features lockable plug and socket connectors for quick release. It also provides the option of Steady State DC (SSDC) output.



241 Bar

The Meech Model 241 bar has been designed specifically for the electronics and cleanroom industries. Extruded in white FRABS for strength and rigidity, the bar provides powerful long range ionisation. The bar is connected via plug and socket to a Meech Model 233 Pulsed DC Controller. Bars can be supplied upon request with special pin pitches to suit specific requirements.



Customers opinion:

“Contamination will always be a concern, however, being able to call on the expertise at Meech International, means we are confident that any issues can be overcome. We have been impressed with their knowledge of static and how it affects our industry and see them as partners when integrating static control solutions.”

~ Production Manager Cleanrooms, Sovrin, UK

Cleanroom 200 Series



251 Ionising Gun

Meech's Model 251 Ion Gun is a robust, lightweight injection moulded product for use with the Model 233 Pulsed DC Controller. It is suitable for contamination blow-off and neutralisation of static charges in electronic applications and cleanroom environments. It is quick, easy and safe to use. Supplied with 2 metres of cable as standard.



261 Ionising Nozzle

Meech's Model 261 Ion Nozzle is a small, lightweight ioniser, designed for use with the Model 233 Pulsed DC Controller. It is suitable for installation into machinery and equipment used within electronic and cleanroom environments. It is quick to install, using the optional mounting bracket, and easy and safe to use.



261 Flexi Ionising Nozzle

The Meech Model 261 Flexi Nozzle is a small, lightweight ioniser with the discharge outlet extended by flexible knuckle trunking. The 261 Flexi Nozzle is designed for use with Meech Pulsed DC Controllers and is suitable for installation into machinery and equipment in both industrial and electronics environments. It is particularly suited to high speed applications such as sheet delivery systems. The addition of flexible knuckle trunking enables the system to deliver ionized air with accuracy into difficult to reach places, where conventional systems would be ineffective or impossible to install.



271, 272, 273 Flexible Ion Nozzle

The Model 271 Flexible Ion Nozzle is a compact, "hands free" ioniser, designed for repetitive cleaning tasks. It is powered by the Model 233 Pulsed DC Controller. It is suitable for electronic and cleanroom environments and is quick to install and easy and safe to use.

The 272 includes a pneumatic foot pedal that allows the operator to regulate both the flow of air and activate the ionization field "hands free".

The 273 includes a standard foot switch which allows the operator to regulate the air flow to the flexible nozzle.

"By installing the Meech 241 static control ioniser system on our machines, we can ensure maximum effectiveness and our customers can achieve better repair yields throughout their polarisation replacement process. We have also been able to increase our customer base by introducing smaller companies to the LCD repair business."

~ Company Director, Clarion Design, UK



Meech International

2 Network Point
Range Road, Witney
Oxfordshire
OX29 0YN
UK

Tel: +44 (0) 1993 706700
Fax: +44 (0) 1993 776977
e-mail: sales@meech.com

Meech Static Eliminators USA Inc

2915 Newpark Drive
Norton OH 44203
USA

Tel: +1 330 564 2000 / 1 800 232 4210
Fax: +1 330 564 2005
e-mail: info@meech.com

Meech Elektrostatik SA

Av C Grandprez 27
B 4970, Stavelot
Belgium

Tel: +32 8086 2983
Fax: +32 8086 2821
e-mail: mesa@meech.com

Meech CE

2151 Fót
Széchenyiút. 46
Hungary

Tel: +36 27535075
Fax: +36 27535076
e-mail: ce@meech.com

Meech China

Room 205, Huana Hotel Office Tower
No. 1733 Lianhua Road
Shanghai 201103
China PR

Tel: +86 21 6405 7737
Fax: +86 21 6405 7736
Mobile: 01380169 2517
email: china@meech.com

All you need, from the best in the business

Meech is also a leading provider of:

- **Web Cleaning Systems** – Typically used within the printing and packaging industries to remove contamination, improve print quality and increase productivity.
- **JetStream Air Knife Systems** – Energy efficient air knife systems that are used for contamination and surface moisture removal.
- **Air Technology Equipment** – Compressed air products that save energy, reduce noise levels and provide efficient cooling.