

Fast-Set Plural-Component Equipment and Accessories

For Foam and Coatings Applications



PROVEN QUALITY. LEADING TECHNOLOGY.

Engineered for Performance

Expect superior foam and coatings results with Graco® Plural-Component Proportioners and Spray Guns



Complete systems for superior results

Whether you're spraying polyurethane foam insulation in a home, commercial building or rooftop, or applying polyurea to coat a bedliner or to protect any other substrate, Graco Plural-Component Proportioner Systems help you get the job done with superior results.

You'll discover that Graco equipment is easy to use, rugged, reliable and easy to maintain.

From entry-level models to high-output systems, there's a Graco Plural-Component Proportioning System that's ideal for your application.

Applications:

Polyurethane Foam

- Residential wall insulation
- Rim and band joist
- Roof insulation
- Aerospace
- Commercial walls

Coatings

- Concrete joint filling
- Marine and shipbuilding
- Potable water
- Wastewater treatment
- Truck bedliners
- Secondary containment
- Adhesives and caulk
- Waterproofing
- Tank and pipe coating
- Foundations

Build a complete system in just a few steps

1 SELECT A PROPORTIONER

Choose an air, electric or hydraulic model.

KEY FEATURES:

- Quick knockdown fluid sections
- Optional data reporting capabilities
- Foam models rated at 2000 psi (138 bar, 13.8 MPa)
- Coatings models rated up to 3500 psi (240 bar, 24.0 MPa)

2 SELECT HEATED HOSES

Choose from pressure ratings of 2000 psi or 3500 psi (138 to 240 bar, 13.8 to 24.0 MPa).

Choose 3/8 in or 1/2 in IDS.

3 SELECT HEATED WHIP HOSE

Choose from pressure ratings of 2000 psi or 3500 psi (138 to 240 bar, 13.8 to 24.0 MPa).

Choose 1/4 in or 3/8 in IDS.

4 SELECT A GUN

Choose an air-purge, mechanical-purge or liquid-purge gun with a round or flat pattern.

5 SELECT SUPPLY PROCESSING EQUIPMENT

5 SUPPLY PUMP

Choose from diaphragm or piston pumps for standard materials in drum-mount or wall-mount. Select a 2:1 piston pump for materials with higher viscosities.

6 AGITATOR KITS

Choose a kit to agitate your resin for a consistent coating. Graco's patented Twistork® agitators are very low shear to minimize material frothing.

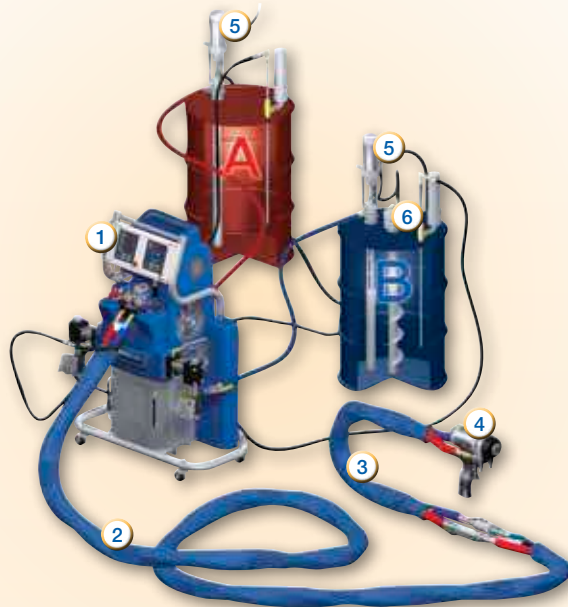

Air, Electric and Hydraulic Systems

No matter what the application, Graco has the solution



Which system is right for you?

AIR-DRIVEN

- Entry-level proportioning system
- Low-output applications
- Easy to use
- Minimal system feedback for operator



Reactor® A-25

ELECTRIC

- The most popular proportioning system
- High value for great performance
- Mid- to high-output applications
- Provides operator with material data and system diagnostics for total control



Reactors E-10, E-20, E-30, E-XP1, E-XP2

HYDRAULIC

- Top of the line system for high-production professionals
- Highest value for the greatest performance
- High-output applications
- Ideal for in-plant OEMs
- Provides superior, uninterrupted performance
- Provides operator with material data and system diagnostics for total control



Reactors H-25, H-40, H-50, H-XP2, H-XP3

PERFORMANCE CHARTS

Use these charts to help identify the proportioner that will work most efficiently with each mix chamber. Flow rates are based on a material viscosity of 60 cps. See examples below.

HOW TO USE THESE GRAPHS

- Select spray pressure
- Select mix chamber or flow rate
- Choose proportioner model

Note: Darker shading includes proportioner models shown in lighter shaded areas.

FOAM EXAMPLE

Mix chamber: AR6060 (03)
 Pressure: 1250 psi
 Flow rate: 22 lb/min*
 Proportioners H-25, E-30, H-40, H-50

COATING EXAMPLE

Mix chamber: AR2929 (00)
 Pressure: 1500 psi
 Flow rate: 0.9 gpm*
 Proportioners E-XP1, E-XP2, H-XP2, H-XP3

* Output of flat tip will be slightly less than round equivalent.

PROPORTIONERS FOR FOAM

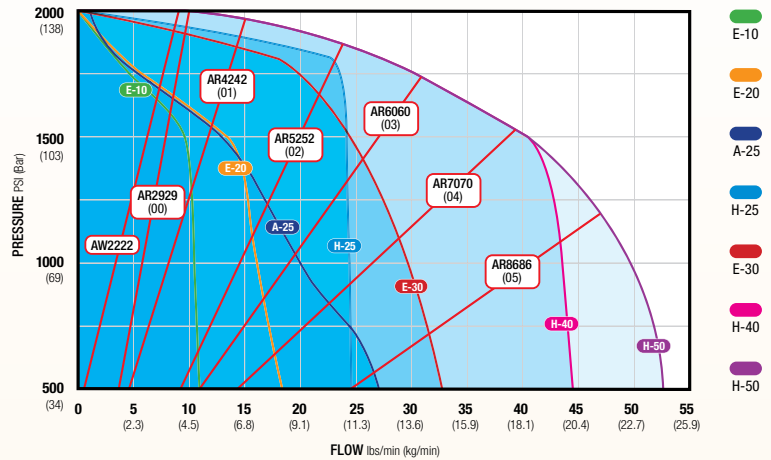

PROPORTIONERS FOR COATINGS

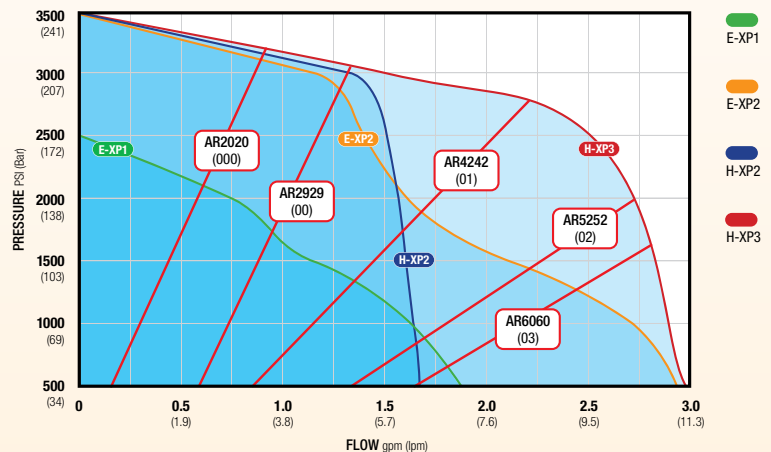

Electric Proportioners

Preferred choice for medium- to high-output foam or coatings applications

Reactor E-Series: High performance at an outstanding value

Equipped with material data and system diagnostics, Reactor E-Series proportioners provide total control. Advanced features provide longer equipment life, more uptime for your spray day and overall Graco reliability.

- Circulation valves with longer-lasting seals
- Heat transformers that don't require tap settings
- Longer-lasting modular heater control boards that minimize downtime
- Models include: E-10, E-20, E-30, E-XP1, E-XP2

Digital Heat and Pressure Controls

Allow you to precisely program temperatures and pressures, and monitor machine performance

Powerful Hybrid Heaters

Provide better temperature control

ISO Pump Lube System

Prevents isocyanate crystallization on the pump seal and shaft

Quick Knockdown Lower Pumps

For easy disassembly and maintenance

Rugged, Portable Design

Easy maneuverability around the jobsite



Electric Motor

Provides superior efficiency and performance

Circulation Valves

Reduce isocyanate crystallization while offering more controlled pressure balancing

Hose Control

Reliable and accurate hose connection system. Flexible fluid temperature sensor allows you to monitor and control temperature closer to the gun.

Heat Platform

Circuit board is divided into easy-to-replace modules that simplify troubleshooting and maintenance, maximizing spray time



COMPACT AND PORTABLE

◀ Reactor E-10

Get smaller jobs done fast without sacrificing performance. Graco's portable E-10 sprayers are ideal for plural-component spray, joint-fill jobs and touch-ups.

- Electric power is low draw and plugs into standard outlets
- Intuitive start, stop and digital temperature display with single knob operation
- Easy-to-service fluid section reduces maintenance and increases productivity
- Electric motor improves performance and reduces operating costs
- Heaters and hose give up to 2000 watts to pre-heat circulating material

Applications

Foam Insulation

- Rim joists
- Roof patching
- Prep work
- Window repair

Coatings

- Small industrial jobs
- Concrete joint filling and flooring applications
- Small tank spraying using cold spray polyurea
- Industrial maintenance
- Hybrid polyureas

Hydraulic Proportioners

Top of the line equipment for high-production professionals

Reactor H-Series: Superior power and performance

Graco's line of hydraulic Reactors brings increased yield and performance to high-output spraying. Hydraulic systems are the choice of spraying professionals who want to reap the benefits of the latest spraying technologies and add productivity to boost their bottom line.

- Adjustable pressure imbalance for tighter or looser ratio error detection
- Flexibility to change A or B pumps for fixed ratio application other than 1:1
- Models include: H-25, H-40, H-50, H-XP2, H-XP3 and H-VR

Digital Heat and Pressure Controls

Allow you to precisely program temperatures and pressures, and monitor machine performance

Circulation Valves

Reduce isocyanate crystallization while offering more controlled pressure balancing

Hose Control

Reliable and accurate hose connection system. Flexible fluid temperature sensor allows you to monitor and control temperature closer to the gun.

ISO Pump Lube System

Prevents isocyanate crystallization on the pump seal and shaft

Powerful Hybrid Heaters

Heat material quickly and maintain temperature set points – even when spraying at maximum flow rates

Horizontal Pumps

Positive displacement pumps are easy to service and provide smoother changeover for maintaining best spray pattern

Troubleshooting Y-Strainer

Analog temperature and pressure gauges are standard

Heat Platform

Circuit board is divided into easy-to-replace modules that simplify troubleshooting and maintenance, maximizing spray time

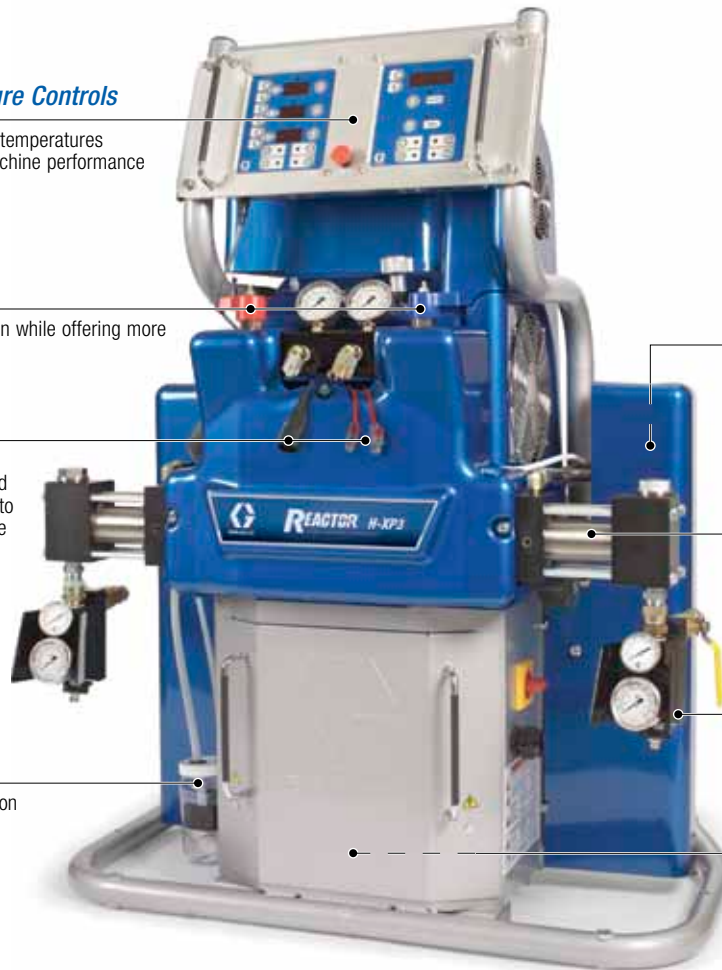

VARIABLE RATIO DISPENSING

◀ Reactor H-VR – Variable Ratio Hydraulic Proportioner

The Reactor H-VR is a variable ratio proportioner that combines proven Graco hydraulic Reactor technology with variable ratio capabilities.

- For applications that require a range or difference in volumetric ratio
- Infinitely adjustable volume ratio from 1:1 to 2.5:1
- Dispenses polyurethane foams and polyurea coatings
- Rated for 3500 psi max working pressure
- 15,300 watt heaters

Ordering Information

Gun and hose sold separately

256886 Reactor H-VR, 230-volt, 3-ph

256887 Reactor H-VR, 400-volt, 3-ph

Air-Driven Proportioners

Easy-to-use, entry-level system for low-output applications

Reactor A-25: Superior performance with long-lasting durability

The Reactor A-25 is a Graco-engineered spray foam proportioner that gives you the reliability you expect on the jobsite. It maintains consistent temperature control, even when you're spraying at maximum flow rates - resulting in better quality foam.

- Maintains temperature setpoints for better yield
- Maintains consistent output pressure for uniform spray pattern
- Easy to operate and maintain
- Best choice for affordability and long-lasting durability

DataTrak™ Control

- Resettable counter tracks material usage

Three Heat Zones

- Three independent heat zones – ISO, resin and hose heat
 - Provide accurate heat control for reliable spraying to handle different chemical viscosities
 - Digital temperature controls

Recirculation Manifold

- A quick, easy way to balance system pressures

NXT® Air Motor

- Low air consumption for increased efficiency
- Muffler provides low operating noise levels
- Air valve provides smooth and rapid changeover

Hybrid Heater

- Provides better temperature control

Quick Knockdown Lower Pumps

- For easy disassembly and maintenance

ISO Pump Lube System

- Prevents isocyanate crystallization on the pump seal and shaft



Transfer Pumps and Agitator Kits

Engineered for more output, better performance and great value

T1 AND T2 TRANSFER PUMP FAMILY ▼

	Part Number	Ratio	Maximum output – continuous	Maximum output – intermittent	Maximum input air pressure	Maximum output fluid pressure	Maximum ambient temperature	Maximum fluid temperature	Weight	Dimensions	Manual Number
T1	256200	2:1	2.5 gpm (9.5 lpm)	4.0 gpm (15 lpm)	180 psi (12 bar, 1.2 MPa)	360 psi (25 bar, 2.5 MPa)	120°F (50°C)	190°F (88°C)	18 lb (8.4 kg)	51.5 in (130.8 cm) length; 2.6 in (66 mm) diameter (cap)	312766
T2	295616	2.25:1	5.0 gpm (19 lpm)	7.5 gpm (28 lpm)	180 psi (12 bar, 1.2 MPa)	405 psi (28 bar, 2.8 MPa)	120°F (50°C)	190°F (88°C)	21 lb (9.5 kg)	54 in (137 cm) length; 3.5 in (89 mm) diameter (cap)	311882

- The T2 design doubles the output – from 2.5 to 5.0 gpm – able to keep up with high-output proportioners
- The smaller T1 pump allows for lower 2:1 output, ideal for spraying applications
- Quick-disconnect feature allows easier drum removal and faster change-outs
- Improved fluid intake easily handles higher viscosity materials – even in cold conditions
- Reliable and cost-effective



Quick-release Bung Adapter

For easy drum removal without interference from hose connections

Corrosion-resistant Components

Stainless steel wetted parts

PTFE Seals

Improved performance for less maintenance



◀ TWISTORK HELIX MIXER

- Air-operated with a variable-speed, 1.5 HP motor, capable of 100 psi (7 bar, 0.7 MPa) maximum working pressure
- Available in carbon steel and stainless steel
- Built for long-life, corrosion-resistance and structural integrity
- Patented, helix-shaped mixing blades are threaded through a closed-head drum's standard bung opening
- Heavy-duty agitator features lube-free assembly, eliminating fluid contamination
- Gentle mixing reduces degradation and splashing, compared to propeller blades

Graco Proportioners for Foam and Coatings

Technical Specifications and Ordering Information



FOAM PROPORTIONERS

	Air-Driven	Electric (E Series)			Hydraulic (H Series)
MODEL ▶	A-25	E-10	E-20	E-30	H-25
Max Working Pressure	2000 psi (138 bar, 13.8 MPa) 28 scfm air consumption@100 psi	2000 psi (138 bar, 13.8 MPa)	2000 psi (138 bar, 13.8 MPa)	2000 psi (138 bar, 13.8 MPa)	2000 psi (138 bar, 13.8 MPa)
Min Working Pressure	N/A	N/A	N/A	N/A	850 psi (59 bar, 5.9 MPa)
Max Hose Length	210 ft (64 m)	105 ft (32 m)	210 ft (64 m)	310 ft (94 m)	310 ft (94 m)
Max Fluid Temp	190°F (88°C)	160°F (71°C)	190°F (88°C)	190°F (88°C)	190°F (88°C)
Output	25 lb (11.4 kg)/min	12 lb (5.4 kg)/min	20 lb (9 kg)/min	30 lb (13.6 kg)/min	22 lb (10 kg)/min
Weight	250 lb (113 kg)	Heated: 160 lb (72 kg) Unheated: 150 lb (68 kg)	342 lb (155 kg)	400 lb (181 kg)	8 kW: 535 lb (243 kg) 15 kW: 562 lb (255 kg)
Ordering Information	<p>With 6.0 kW heater:</p> <p>40A–230V, 1-ph 262614 (Bare) AP2614 (AP Pkg) CS2614 (CS Pkg) P22614 (P2 Pkg)</p> <p>32A–230V, 3-ph 262614 (Bare) AP2614 (AP Pkg) CS2614 (CS Pkg) P22614 (P2 Pkg)</p> <p>18.5A–380V, 3-ph (4-wire) 262614 (Bare) AP2614 (AP Pkg) CS2614 (CS Pkg) P22614 (P2 Pkg)</p>	<p>With 1.7 kW heater:</p> <p>120V, 2-cord 249570 (Bare) AP9570 (AP Pkg) CS9570 (CS Pkg)</p> <p>With 2.0 kW heater:</p> <p>240V, 2-cord 249571 (Bare) AP9571 (AP Pkg) CS9571 (CS Pkg)</p> <p>240V, 1-cord 249572 (Bare) AP9572 (AP Pkg) CS9572 (CS Pkg)</p> <p>Unheated ambient system:</p> <p>120V 249576 (Bare) 249806 (Pkg)</p> <p>240V 249577 (Bare) 249808 (Pkg)</p>	<p>With 6.0 kW heater:</p> <p>48A–230V, 1-ph 259025 (Bare) AP9025 (AP Pkg) CS9025 (CS Pkg) P29025 (P2 Pkg)</p> <p>32A–230V, 3-ph 259034 (Bare) AP9034 (AP Pkg) CS9034 (CS Pkg) P29034 (P2 Pkg)</p> <p>24A–400V, 3-ph 259030 (Bare) AP9030 (AP Pkg) CS9030 (CS Pkg) P29030 (P2 Pkg)</p>	<p>With 10.2 kW heater:</p> <p>78A–230V, 1-ph 259026 (Bare) AP9026 (AP Pkg) CS9026 (CS Pkg) P29026 (P2 Pkg)</p> <p>50A–230V, 3-ph 259035 (Bare) AP9035 (AP Pkg) CS9035 (CS Pkg) P29035 (P2 Pkg)</p> <p>34A–400V, 3-ph 259031 (Bare) AP9031 (AP Pkg) CS9031 (CS Pkg) P29031 (P2 Pkg)</p> <p>With 15.3 kW heater:</p> <p>100A–230V, 1-ph 259057 (Bare) AP9057 (AP Pkg) CS9057 (CS Pkg) P29057 (P2 Pkg)</p> <p>62A–230V, 3-ph 259058 (Bare) AP9058 (AP Pkg) CS9058 (CS Pkg) P29058 (P2 Pkg)</p> <p>35A–400V, 3-ph 259059 (Bare) AP9059 (AP Pkg) CS9059 (CS Pkg) P29059 (P2 Pkg)</p>	<p>With 8.0 kW heater:</p> <p>69A–230V, 1-ph 255400 (Bare) AP5400 (AP Pkg) CS5400 (CS Pkg) P25400 (P2 Pkg)</p> <p>46A–230V, 3-ph 255401 (Bare) AP5401 (AP Pkg) CS5401 (CS Pkg) P25401 (P2 Pkg)</p> <p>35A–400V, 3-ph 255402 (Bare) AP5402 (AP Pkg) CS5402 (CS Pkg) P25402 (P2 Pkg)</p> <p>With 15.3 kW heater:</p> <p>100A–230V, 1-ph 255406 (Bare) AP5406 (AP Pkg) CS5406 (CS Pkg) P25406 (P2 Pkg)</p> <p>59A–230V, 3-ph 255407 (Bare) AP5407 (AP Pkg) CS5407 (CS Pkg) P25407 (P2 Pkg)</p> <p>35A–400V, 3-ph 255408 (Bare) AP5408 (AP Pkg) CS5408 (CS Pkg) P25408 (P2 Pkg)</p>
Operation manual	3A1569	311075	312065	312065	312062
Repair manual	3A1570	311075	312066	312066	312063

Packages include spray hose, whip hose and gun.



COATINGS PROPORTIONERS

		Electric (E Series)		Hydraulic (H Series)	
H-40	H-50	E-XP1	E-XP2	H-XP2	H-XP3
2000 psi (138 bar, 13.8 MPa)	1700 psi (117 bar, 11.7 MPa) 1-ph 2000 psi (138 bar, 13.8 MPa) 3-ph	2500 psi (172 bar, 17.2 MPa)	3500 psi (240 bar, 24.0 MPa)	3500 psi (240 bar, 24.0 MPa)	3-ph: 3500 psi (240 bar, 24.0 MPa) 1-ph: 3200 psi (221 bar, 22.1 MPa)
600 psi (41 bar, 4.1 MPa)	600 psi (41 bar, 4.1 MPa)	N/A	N/A	1200 psi (83 bar, 8.3 MPa)	850 psi (59 bar, 5.9 MPa)
410 ft (125 m)	410 ft (125 m)	210 ft (64 m)	310 ft (94 m)	310 ft (94 m)	410 ft (125 m)
190°F (88°C)	190°F (88°C)	190°F (88°C)	190°F (88°C)	190°F (88°C)	190°F (88°C)
45 lb (20 kg)/min	52 lb (23.6 kg)/min	1.0 gpm (3.8 lpm)	2.0 gpm (7.6 lpm)	1.5 gpm (5.7 lpm)	2.8 gpm (10.6 lpm)
597 lb (271 kg)	597 lb (271 kg)	342 lb (155 kg)	438 lb (199 kg)	562 lb (255 kg)	597 lb (271 kg)
<p>With 12.0 kW heater: 100A–230V, 1-ph 253400 (Bare) AP3400 (AP Pkg) P23400 (P2 Pkg)</p> <p>With 15.3 kW heater: 71A–230V, 3-ph 253401 (Bare) AP3401 (AP Pkg) P23401 (P2 Pkg)</p> <p>41A–400V, 3-ph 253402 (Bare) AP3402 (AP Pkg) P23402 (P2 Pkg)</p> <p>With 20.4 kW heater: 95A–230V, 3-ph 253407 (Bare) AP3407 (AP Pkg) P23407 (P2 Pkg)</p> <p>52A–400V, 3-ph 253408 (Bare) AP3408 (AP Pkg) P23408 (P2 Pkg)</p>	<p>With 12.0 kW heater: 100A–230V, 1-ph 253725 (Bare) AP3725 (AP Pkg) P23725 (P2 Pkg)</p> <p>With 15.3 kW heater: 71A–230V, 3-ph 253726 (Bare) AP3726 (AP Pkg) P23726 (P2 Pkg)</p> <p>41A–400V, 3-ph 253727 (Bare) AP3727 (AP Pkg) P23727 (P2 Pkg)</p> <p>With 20.4 kW heater: 95A–230V, 3-ph 256505 (Bare) AP6505 (AP Pkg) P26505 (P2 Pkg)</p> <p>52A–400V, 3-ph 256506 (Bare) AP6506 (AP Pkg) P26506 (P2 Pkg)</p>	<p>With 10.2 kW heater: 69A–230V, 1-ph 259024 (Bare) AP9024 (AP Pkg) P29024 (P2 Pkg)</p> <p>43A–230V 3-ph 259033 (Bare) AP9033 (AP Pkg) P29033 (P2 Pkg)</p> <p>24A–400V, 3-ph 259029 (Bare) AP9029 (AP Pkg) P29029 (P2 Pkg)</p>	<p>With 15.3 kW heater: 100A–230V, 1-ph 259028 (Bare) AP9028 (AP Pkg) P29028 (P2 Pkg)</p> <p>62A–230V, 3-ph 259036 (Bare) AP9036 (AP Pkg) P29036 (P2 Pkg)</p> <p>35A–400V, 3-ph 259032 (Bare) AP9032 (AP Pkg) P29032 (P2 Pkg)</p>	<p>With 15.3 kW heater: 100A–230V, 1-ph 255403 (Bare) AP5403 (AP Pkg) P25403 (P2 Pkg)</p> <p>59A–230V, 3-ph 255404 (Bare) AP5404 (AP Pkg) P25404 (P2 Pkg)</p> <p>35A–400V, 3-ph 255405 (Bare) AP5405 (AP Pkg) P25405 (P2 Pkg)</p>	<p>With 12.0 kW heater: 100A–230V, 1-ph 253403 (Bare) AP3403 (AP Pkg) P23403 (P2 Pkg)</p> <p>With 20.4 kW heater: 95A–230V, 3-ph 253404 (Bare) AP3404 (AP Pkg) P23404 (P2 Pkg)</p> <p>52A–400V, 3-ph 253405 (Bare) AP3405 (AP Pkg) P23405 (P2 Pkg)</p>
312062	312062	312065	312065	312062	312062
312063	312063	312066	312066	312063	312063

Packages include spray hose, whip hose and gun.

Liquid-Purge Guns

Unprecedented features that will change the way you spray

Fusion® CS with ClearShot™ Technology – A new class of spray gun

Graco's new Fusion CS plural-component spray gun with ClearShot (CS) Technology delivers improved productivity and performance throughout the spray day. The secret of the revolutionary ClearShot Technology is the ClearShot Liquid which is inserted into the gun's handle. Every time you pull the trigger, ClearShot Liquid is dispensed into the mix chamber and helps remove any built-up chemical – keeping it clean.

CLEARSHOT TECHNOLOGY

- ClearShot Liquid helps remove built-up material – virtually eliminating drilling of mix chamber
- Maximizes daily spraying uptime and annual productivity
- Maintains patterns and maximizes each kit with a clean mix chamber, saving time and money on material



Liquid-Purge

- Reduces purge air by 75%, minimizing material blowback
- Gain flexibility and maneuverability to spray in small, tight areas

Industry-First Quick-Change Front End

- Swap out fluid head in seconds
- Non-stick polymer cover for easy cleanup
- "Air knife" – reduces material buildup

Variable Flow Setting

- Switch from large to small spray patterns in seconds
- Ten different settings

New Manifold

- Easy on/off valves
- Check valves block fluid flow when manifold is disconnected
- Quick filter screen change-outs



New ClearShot Cartridge

Keeps gun mix chamber clear

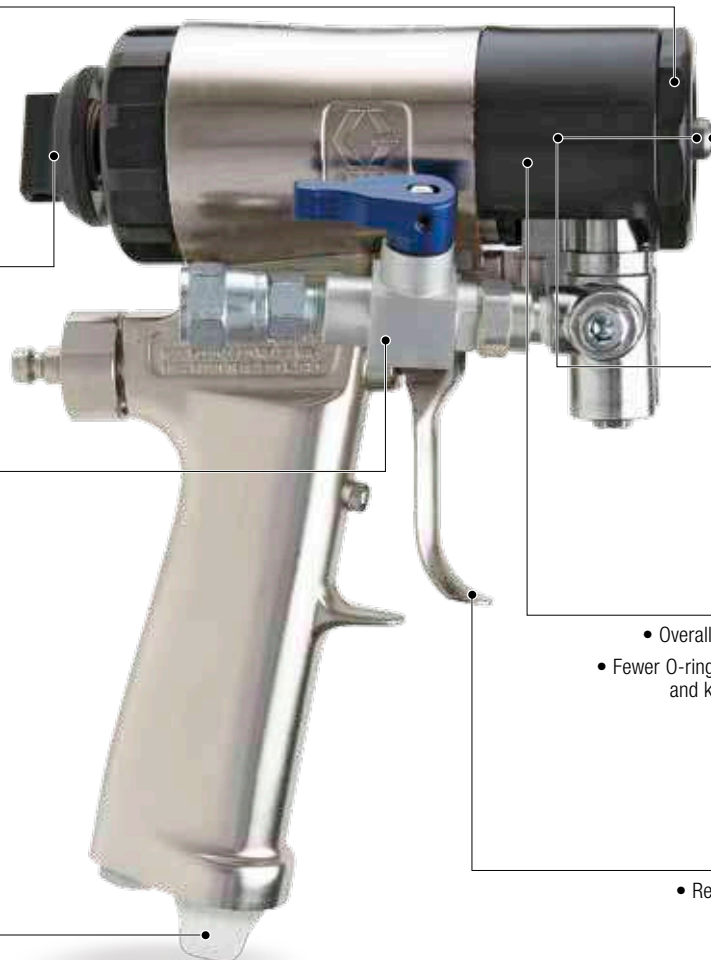

Chromex®-Coated Side Seals and Mix Chamber

- More resistance to corrosion and wear
- Save time and money in replacements over the long-term

Screw-in-Place Side Seals

- Overall maintenance is quicker and simpler
- Fewer O-rings ensure better crossover protection and keep appropriate mix and proportions of material for better end results

Faster/Shorter Trigger Pull

- Responsive trigger delivers quick shots
- Diminishes operator fatigue

Air-Purge Guns

Plural-component spraying made easy

Fusion AP – Easy to use, easy to maintain

- Air-blast tip cleaning reduces build-up and tip clogging
- Hardened stainless steel mix chambers are built to last
- Longer life side seals reduce maintenance and let you spray a wider range of materials – choose from hardened stainless steel or PolyCarballoy options
- Advanced mix module and tip design improves mixing
- Solvent-resistant components and O-rings let you soak the whole gun without swelling or damage
- Daily maintenance in a matter of seconds with the quick-shot grease port
- Easy-to-use design makes maintenance quick and easy



Quick-Release Fluid Housing

Easily change mix chambers without tools

Hand-Tightened Front Cap

Clean and maintain seals and mix chamber without tools

Cyclone-Mix™ Chamber

Hardened stainless steel construction for longer life

Durable Side Seals

Rugged stainless steel or PolyCarballoy construction for longer life

Check Valves with Screens

Cartridge design for easy maintenance

Ergonomic Handle

Smooth curved handle improves operator comfort and reduces fatigue

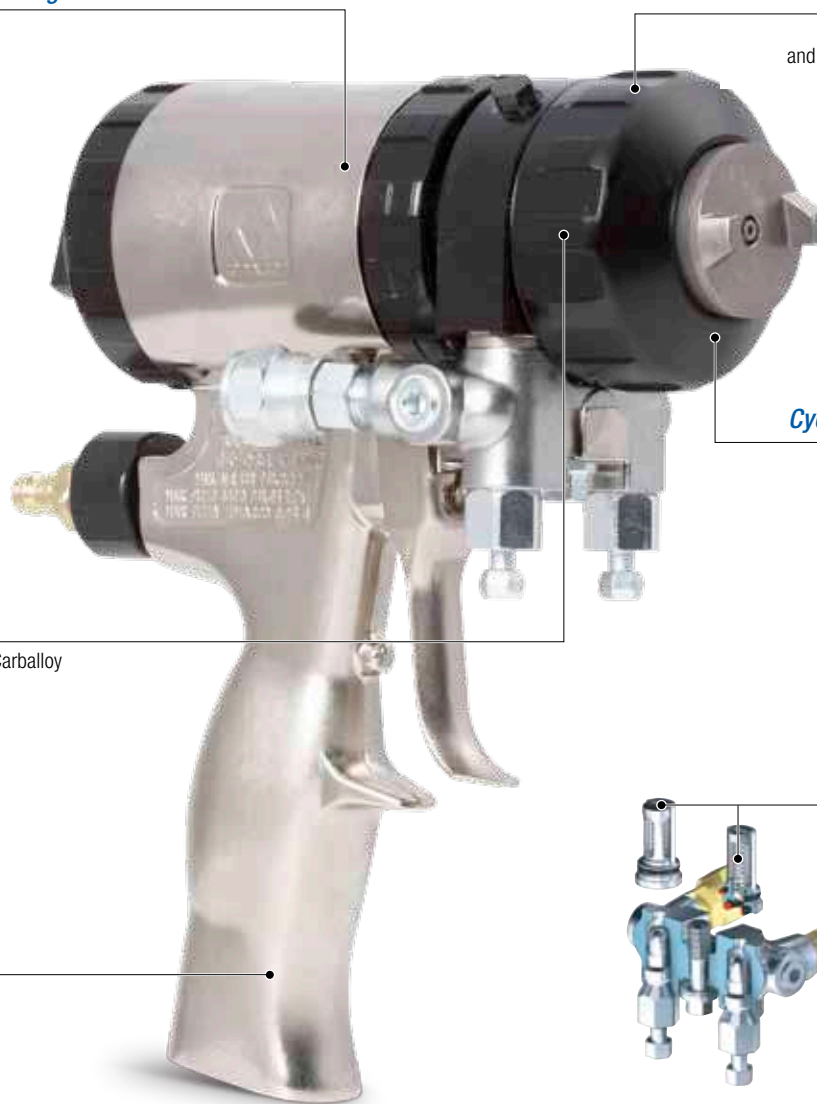

Air-Purge Guns

Plural-component spraying made easy

PROBLER® P2 – Compact and ergonomic

Recognized by the industry for its superior performance, the P2 gun's light, easy-to-handle design lets you spray and maneuver easily – even in difficult spraying positions. At the end of the day, maintenance is easy. No cleaning small air passages with tiny drill bits. The P2 has check valves that separate the liquid portion and dry side of the gun.

- Responsive trigger action – double piston design provides more than 300 pounds (136 kg) of triggering force
- The mix chamber insert can be replaced without replacing the entire chamber
- Anti-crossover design virtually eliminates possibility of material entering the air piston

P2 ELITE

- P2 model's side blocks offer alternate hose routing configurations
- Allows access to ISO and resin filters without removing side blocks
- Allows for use of additional accessories



Grease Fitting

For quick daily maintenance

Two-Piece Mix Chamber

Designed to reduce downtime

Powerful Dual Air Piston

- Provides strong trigger force
- Dramatically increases mix chamber pull-back pressure

Ergonomic Handle and Balanced Design

Comfortable, compact and lightweight



Mechanical-Purge Guns

Best material mix on the market

Fusion MP – Designed for superior mixing

- Handles from very low output, thin mil applications to large, high flow, high-output applications just by changing the mix module and tip
- Easy mechanical cleaning – mix modules and tips are cleaned with a drill bit
- Smoother finish and better atomization
- Offers more advanced features than all other mechanical-purge guns combined

LONG-LASTING MIX MODULES PROVIDE EXCELLENT MIXING

- Advanced mix module and tip design provides excellent mix and material properties
- PolyCarballoy mix modules for proven long life
- CeramTip™ is durable and easy to change
- Significantly reduces repair and maintenance costs

GX-7 GUN

- Excellent for polyurethane foams and elastomeric coatings
- Great mixing and pattern control with its unique internal impingement mixing design
- Designed to handle the toughest job-site conditions



Purge Rod

Easy-to-set, one piece rod for longer life

CeramTip

Durable and easy to change

Adjustable Front Packing

PolyCarballoy Mix Module

For proven long life

Ergonomic Handle

Smooth curved handle improves operator comfort and reduces fatigue

Check Valves with Screens

Cartridge design for easy maintenance

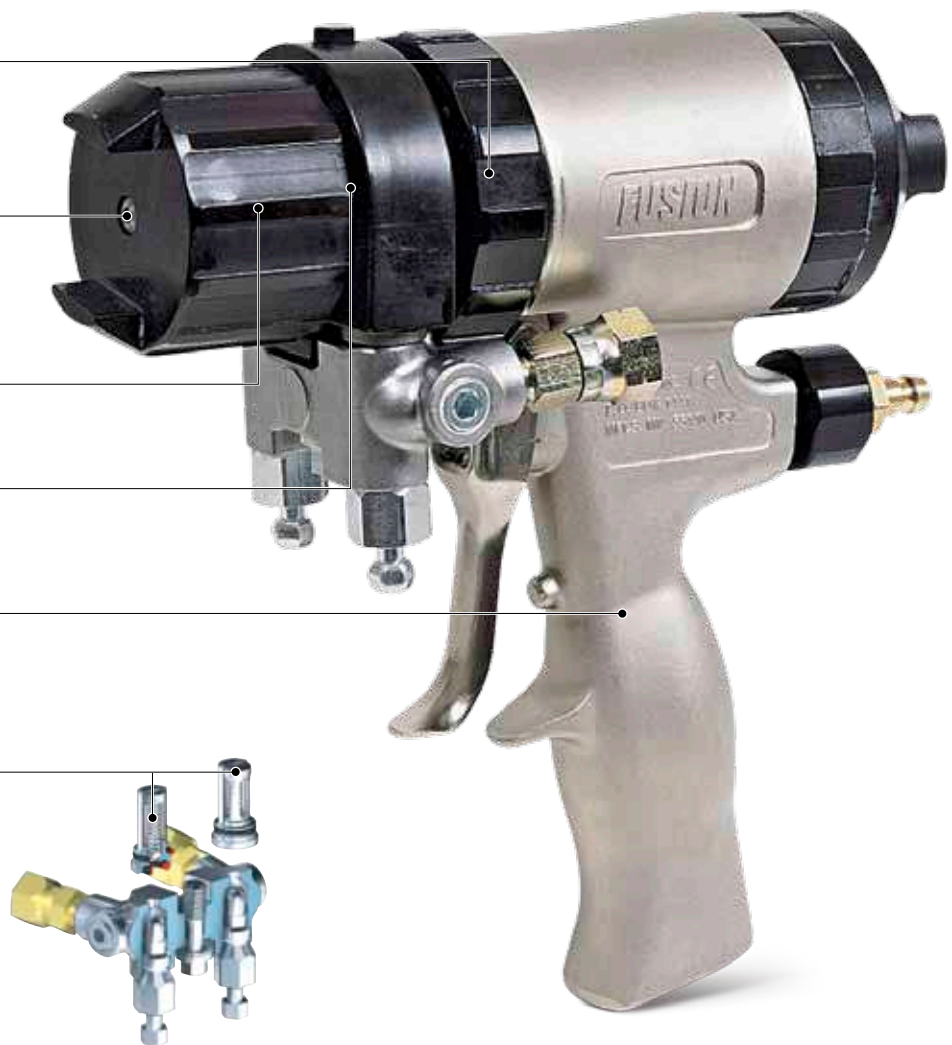

Graco Plural-Component Spray Guns

Technical Specifications



MODEL ▶	Liquid-Purge		Air-Purge	
	FUSION CS	FUSION AP	P2	GAP PRO
Materials sprayed	Foam and coatings	Foam and coatings	Foam and coatings	Foam and coatings
Maximum Output	25 lb/min (11.3 kg/min)	50 lb/min (22.7 kg/min)	40 lb/min (18 kg/min)	40 lb/min (18 kg/min)
Minimum Output	< 1 lb/min (<0.45 kg/min)	3 lb/min (1.4 kg/min)	3 lb/min (1.4 kg/min)	3 lb/min (1.4 kg/min)
Maximum Fluid Working Pressure	3500 psi (240 bar, 24.0 MPa)	3500 psi (240 bar, 24.0 MPa)	3200 psi (221 bar, 22.1 MPa)	3000 psi (207 bar, 20.7 MPa)
Maximum Working Air Inlet Pressure	130 psi (9 bar, 0.9 MPa)	130 psi (9 bar, 0.9 MPa)	110 psi (7.6 bar, 0.76 MPa)	125 psi (8.6 bar, 0.86 MPa)
Maximum Fluid Temperature	200°F (93°C)	200°F (93°C)	200°F (93°C)	200°F (93°C)
Weight (with manifold)	2.6 lb (1.2 kg)	3.1 lb (1.4 kg)	3.0 lb (1.4 kg)	2.7 lb (1.2 kg)
Air inlet size	1/4 npt quick disconnect nipple	1/4 npt quick disconnect nipple	1/4 npt	1/4 npt quick disconnect nipple
A Component (ISO) inlet size	-5 JIC; 1/2-20 UNF swivel	-5 JIC; 1/2-20 UNF swivel	-5 JIC; 1/2-20 UNF swivel	-5 JIC; 1/2-20 UNF swivel
B Component (Resin) inlet size	-6 JIC; 9/16-18 UNF swivel	-6 JIC; 9/16-18 UNF swivel	-6 JIC; 9/16-18 UNF swivel	-6 JIC; 9/16-18 UNF swivel
Wetted Parts	Aluminum, stainless steel, plated carbon steel, brass, chemically resistant O-rings	Aluminum, stainless steel, plated carbon steel, brass, chemically resistant O-rings	Aluminum, stainless steel, plated carbon steel, brass, carbide, fluorocarbon O-rings	Aluminum, stainless steel, plated carbon steel, brass, carbide, fluorocarbon O-rings
Gun Dimensions	6.5 x 8.1 x 3.6 in (16.5 x 20.6 x 9.1 cm)	7.5 x 8.1 x 3.3 in (19 x 20.6 x 8.4 cm)	6.9 x 8.7 x 3.5 in (17.5 x 22 x 8.9 cm)	7 x 7 x 4.4 in (17.8 x 17.8 x 11.2 cm)
Instruction manual	312666	309550	313213	311322
Applications	Residential foam insulation, roofing, other polyurethane foams and polyurea	Residential foam insulation, roofing, concrete, waterproofing and other polyurethane foams and elastomeric coatings	Residential foam insulation, roofing, concrete, waterproofing and other polyurethane foams and elastomeric coatings	Residential foam insulation, roofing, concrete, waterproofing and other polyurethane foams and elastomeric coatings





Mechanical-Purge					
FUSION MP	GX-7	GX-7 DI	GX-7-400	GX-8	D-GUN
Foam and coatings	Foam only	Coatings only	Coatings only	Coatings only	Foam only
50 lb/min (22.7 kg/min)	40 lb/min (18 kg/min)	22 lb/min (10.0 kg/min)	8 lb/min (3.6 kg/min)	1.5 lb/min (0.7 kg/min)	16 lb/min (7.2 kg/min)
2 lb/min (0.9 kg/min)	3.5 lb/min (1.6 kg/min)	4 lb/min (1.8 kg/min)	3.5 lb/min (1.6 kg/min)	< 1 lb/min (0.45 kg/min)	2 lb/min (1 kg/min)
3500 psi (240 bar, 24.0 MPa)	3500 psi (240 bar, 24.0 MPa)	3500 psi (240 bar, 24.0 MPa)	3500 psi (240 bar, 24.0 MPa)	3500 psi (240 bar, 24.0 MPa)	1000 psi (69 bar, 6.9 MPa)
130 psi (9 bar, 0.9 MPa)	125 psi (8.6 bar, 0.86 MPa)	125 psi (8.6 bar, 0.86 MPa)	125 psi (8.6 bar, 0.86 MPa)	125 psi (8.6 bar, 0.86 MPa)	110 psi (7.6 bar, 0.76 MPa)
200°F (93°C)	200°F (93°C)	200°F (93°C)	200°F (93°C)	200°F (93°C)	150°F (65°C)
3.4 lb (1.5 kg)	4.1 lb (1.9 kg)	4.1 lb (1.9 kg)	4.1 lb (1.9 kg)	3.1 lb (1.4 kg)	3.1 lb (1.4 kg)
1/4 npt quick disconnect nipple	1/4 npt quick disconnect nipple	1/4 npt quick disconnect nipple	1/4 npt quick disconnect nipple	1/4 npt quick disconnect nipple	1/8 npt quick disconnect nipple
-5 JIC; 1/2-20 UNF swivel	-5 JIC; 1/2-20 UNF swivel	-5 JIC; 1/2-20 UNF swivel	-5 JIC; 1/2-20 UNF swivel	-5 JIC; 1/2-20 UNF swivel	-5 JIC; 1/2-20 UNF swivel
-6 JIC; 9/16-18 UNF swivel	-6 JIC; 9/16-18 UNF swivel	-6 JIC; 9/16-18 UNF swivel	-6 JIC; 9/16-18 UNF swivel	-6 JIC; 9/16-18 UNF swivel	-6 JIC; 9/16-18 UNF swivel
Aluminum, stainless steel, plated carbon steel, brass, polycarbally, chemically resistant O-rings	Aluminum, stainless steel, brass, plated carbon steel, fluorocarbon O-rings	Aluminum, stainless steel, brass, plated carbon steel, fluorocarbon O-rings	Aluminum, stainless steel, brass, plated carbon steel, fluorocarbon O-rings	Aluminum, stainless steel, brass, plated carbon steel, fluorocarbon O-rings	Aluminum, stainless steel, plated carbon steel, brass
7.6 x 8.1 x 3.1 in (19.3 x 20.6 x 7.9 cm)	9 x 9.5 x 4.5 in (22.9 x 24.1 x 11.4 cm)	9 x 9.5 x 4.5 in (22.9 x 24.1 x 11.4 cm)	9 x 9.5 x 4.5 in (22.9 x 24.1 x 11.4 cm)	7 x 7.5 x 2.5 in (17.8 x 19 x 6.4 cm)	8 x 9 x 2.25 in (20.3 x 22.9 x 5.7 cm)
309856	311321	311321	311321	311338	311320
Residential foam insulation, roofing, concrete, waterproofing and other polyurethane foams and elastomeric coatings	Residential foam insulation, roofing, concrete and other polyurethane foams	Medium output fast-set polyurea, polyurethane and hybrid coatings	Low output fast-set polyurea, polyurethane and hybrid coatings	Very low output, fast-set polyurea, polyurethane and hybrid coatings	Low to medium output foam applications

Gun Accessories

Choosing the correct mix chambers, modules and tips

Choosing the right tips and mix chambers

1. Choose a Round or Flat pattern for your tip or mix chamber
(typically round for foam and flat for coatings)
2. Specify "A" and "B" size for your orifice or chamber
3. Specify the desired tip size for your application

LEGEND

Fusion CS:

- RD = Round Mix Chamber
- WD = Wide Mix Chamber
- FL = Flat Mix Chamber
- FT = Flat Tip

Fusion AP:

- AR = Air (purge) Round Mix Chamber
- AF = Air (purge) Flat Mix Chamber
- AW = Air Wide Round Mix Chamber
- FT = Flat Tip (air-purge)

Fusion MP:

- MR = Mechanical (purge) Round
- XR = Direct Impinge Round
- RTM = Round Tip Mechanical (purge)
- MF = Mechanical (Purge) Flat
- XF = Direct Impinge Flat
- FTM = Flat Tip Mechanical (purge)

CHAMBER/ORIFICE CONVERSION

Use this conversion chart to convert the Chamber size to the Orifice size.

Chamber Size	Orifice Size
000	.020
00	.029
01	.042
02	.052
03	.060
04	.070
05	.086

Gun	Mix Chamber/Tip	Pattern at 24 in (61 cm) from target	Polyurea in GPM @ 2000 psi	Foam in lb/min @ 1000 psi	
Fusion CS Round					
		x in (x mm)	x gpm	x lb/min	
	CS20RD	RD2020	5 in (127 mm)	0.5 gpm	3 lb/min
	CS00RD	RD0000	8 in (203 mm)	1.1 gpm	7 lb/min
	CS01RD	RD0101	11 in (279 mm)	1.6 gpm	9 lb/min
	CS02RD	RD0202	12 in (305 mm)	2.4 gpm	14 lb/min
	CS03RD	RD0303	14 in (356 mm)	NA	19 lb/min
Fusion CS Wide Round					
	CS22WD	WD2222	8 in (203 mm)	0.5 gpm	4.5 lb/min
	CS00WD	WD0000	15 in (381 mm)	1.1 gpm	7 lb/min
	CS01WD	WD0101	16 in (406 mm)	1.6 gpm	9 lb/min
	CS02WD	WD0202	18 in (457 mm)	2.4 gpm	14 lb/min
	CS03WD	WD0303	18 in (457 mm)	NA	19 lb/min
Fusion CS Flat					
	CS20F1	FL2020 w/FT0424	10 in (254 mm)	0.5 gpm	3 lb/min
	CS20F2	FL2020 w/FT0438	10 in (254 mm)	0.6 gpm	3 lb/min
	CS00F1	FL0000 w/FT0424	10 in (254 mm)	1.0 gpm	6 lb/min
	CS00F2	FL0000 w/FT0438	10 in (254 mm)	1.2 gpm	7 lb/min
	CS00F3	FL0000 w/FT0624	14 in (356 mm)	1.0 gpm	6 lb/min
	CS00F4	FL0000 w/FT0638	14 in (356 mm)	1.2 gpm	7 lb/min
	CS00F5	FL0000 w/FT0838	18 in (457 mm)	1.2 gpm	7 lb/min
	CS00F6	FL0000 w/FT0848	18 in (457 mm)	1.2 gpm	7 lb/min
	CS01F1	FL0101 w/FT0424	10 in (254 mm)	1.0 gpm	6 lb/min
	CS01F2	FL0101 w/FT0438	10 in (254 mm)	1.3 gpm	9 lb/min
	CS01F3	FL0101 w/FT0624	14 in (356 mm)	1.0 gpm	6 lb/min
	CS01F4	FL0101 w/FT0638	14 in (356 mm)	1.3 gpm	9 lb/min
	CS01F5	FL0101 w/FT0838	18 in (457 mm)	1.3 gpm	9 lb/min
	CS01F6	FL0101 w/FT0848	18 in (457 mm)	1.3 gpm	9 lb/min
	CS02F1	FL0202 w/FT0424	10 in (254 mm)	1.0 gpm	6 lb/min
	CS02F2	FL0202 w/FT0438	10 in (254 mm)	1.3 gpm	9 lb/min
	CS02F3	FL0202 w/FT0624	14 in (356 mm)	1.0 gpm	6 lb/min
	CS02F4	FL0202 w/FT0638	14 in (356 mm)	1.3 gpm	9 lb/min
	CS02F5	FL0202 w/FT0838	18 in (457 mm)	1.3 gpm	9 lb/min
	CS02F6	FL0202 w/FT0848	18 in (457 mm)	1.8 gpm	12 lb/min
Fusion Air-Purge Round					
	246099	AR2020	5 in (127 mm)	0.5 gpm	3 lb/min
	246100	AR2929	8 in (203 mm)	1.1 gpm	7 lb/min
	248617	AR3737	9 in (227 mm)	1.3 gpm	8 lb/min
	246101	AR4242	11 in (279 mm)	1.6 gpm	9 lb/min
	246102	AR5252	12 in (305 mm)	2.4 gpm	14 lb/min
	246103	AR6060	14 in (356 mm)	NA	19 lb/min
	246104	AR7070	15 in (381 mm)	NA	25 lb/min
	246105	AR8686	18 in (457 mm)	NA	35 lb/min
Fusion Air-Purge Wide Round					
	24D581	AW2828	15 in (381 mm)	1.1 gpm	7 lb/min
	NA	AW3333	15 in (381 mm)	1.3 gpm	8 lb/min
	249529	AW3939	16 in (406 mm)	1.6 gpm	9 lb/min
	249530	AW4646	18 in (457 mm)	2.4 gpm	14 lb/min
	NA	AW5757	18 in (457 mm)	NA	19 lb/min
	NA	AW6464	22 in (564 mm)	NA	25 lb/min
	NA	AW8282	24 in (610 mm)	NA	35 lb/min

Gun	Mix Chamber/Tip	Pattern at 24 in (61 cm) from target	Polyurea in GPM @ 2000 psi	Foam in lb/min @ 1000 psi
Fusion Air-Purge Flat				
247101	AF2020 (FT0424)	10 in (254 mm)	0.6 gpm	3 lb/min
247112	AF2929 (FT0438)	10 in (254 mm)	1.2 gpm	7 lb/min
247124	AF4242 (FT0638)	14 in (356 mm)	1.3 gpm	9 lb/min
247138	AF5252 (FT0848)	18 in (457 mm)	1.8 gpm	12 lb/min
Fusion Mechanical-Purge Round				
247003	XR2323 (RTM030)	6 in (152 mm)	0.5 gpm	4 lb/min
247007	XR2929 (RTM040)	8 in (203 mm)	0.9 gpm	7 lb/min
247212 / 247012	MR3535 / XR3535 (RTM040)	8 in (203 mm)	1.2 gpm	8 lb/min
247219 / 247019	MR4747 / XR4747 (RTM055)	9 in (227 mm)	1.7 gpm	10 lb/min
247226 / 247026	MR5757 / XR5757 (RTM070)	10 in (254 mm)	2.7 gpm	15 lb/min
247232	MR6666 (RTM080)	11 in (279 mm)	NA	24 lb/min
247239	MR8282 (RTM090)	12 in (305 mm)	NA	30 lb/min
247246	MR9494 (RTM110)	12 in (305 mm)	NA	39 lb/min
Fusion Mechanical-Purge Flat				
247051	XF1313 (FTM424)	10 in (254 mm)	0.15 gpm	1.5 lb/min
247258 / 247058	MF1818 / XF1818 (FTM424)	10 in (254 mm)	0.3 gpm	2 lb/min
247061	XF 2323 (FTM424)	10 in (254 mm)	0.4 gpm	2.5 lb/min
247265 / 247065	MF2929 / XF2929 (FTM424)	10 in (254 mm)	0.6 gpm	3 lb/min
247275 / 247075	MF3535 / XF3535 (FTM638)	14 in (356 mm)	0.9 gpm	6 lb/min
247282 / 247082	MF4747 / XF4747 (FTM638)	14 in (356 mm)	1.1 gpm	7 lb/min
247289 / 247089	MF5757 / XF5757 (FTM638)	14 in (356 mm)	1.3 gpm	8 lb/min
P2 Gun				
GCP2RA	GC250A w/GC251A	5 in (127 mm)	0.4 gpm	3 lb/min
GCP2R0	GC2500 w/GC2510	9 in (229 mm)	1.1 gpm	8 lb/min
GCP2R1	GC2501 w/GC2511	10 in (254 mm)	1.6 gpm	12 lb/min
GCP2R2	GC2502 w/ GC2512	12 in (305 mm)	2.5 gpm	16 lb/min
GCP2R3	GC2503 w/ GC2513	14 in (356 mm)	NA	24 lb/min
GCP2R4	GC2504 w/ GC2514	15.5 in (394 mm)	NA	29 lb/min
GCP2R5	GC2505 w/ GC2515	18 in (457 mm)	NA	36 lb/min
P2 Elite Gun				
GCP3RA	GC250A w/GC251A	5 in (127 mm)	0.4 gpm	3 lb/min
GCP3R0	GC2500 w/GC2510	9 in (229 mm)	1.1 gpm	8 lb/min
GCP3R1	GC2501 w/GC2511	10 in (254 mm)	1.6 gpm	12 lb/min
GCP3R2	GC2502 w/ GC2512	12 in (305 mm)	2.5 gpm	16 lb/min
GCP3R3	GC2503 w/ GC2513	14 in (356 mm)	NA	24 lb/min
GCP3R4	GC2504 w/ GC2514	15.5 in (394 mm)	NA	29 lb/min
GCP3R5	GC2505 w/ GC2515	18 in (457 mm)	NA	36 lb/min
P2 Auto Gun				
GCP4RA	GC250A w/GC251A	5 in (127 mm)	0.4 gpm	3 lb/min
GCP4R0	GC2500 w/GC2510	9 in (229 mm)	1.1 gpm	8 lb/min
GCP4R1	GC2501 w/GC2511	10 in (254 mm)	1.6 gpm	12 lb/min
GCP4R2	GC2502 w/ GC2512	12 in (305 mm)	2.5 gpm	16 lb/min
GCP4R3	GC2503 w/ GC2513	14 in (356 mm)	NA	24 lb/min
GCP4R4	GC2504 w/ GC2514	15.5 in (394 mm)	NA	29 lb/min
GCP4R5	GC2505 w/ GC2515	18 in (457 mm)	NA	36 lb/min

PART NUMBER EXAMPLES

FT0438

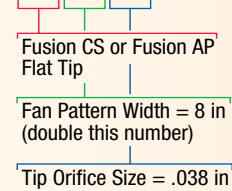

RD0202

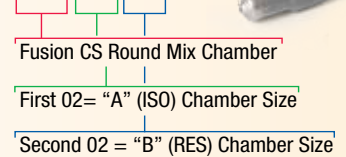

AF4242

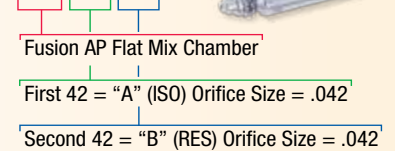

FTM424

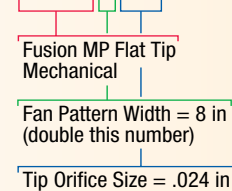

RTM030

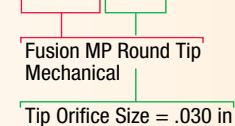

MR 2929

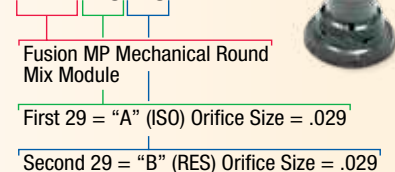

Ordering Information

To get genuine Graco accessories, see your nearest Graco distributor, or call Graco at 877-844-7226

Proportioner Accessories



15B593	Membrane switch shield
15B742	Wire harness extension for display, 50 ft (15 m)
248921	Heated hose controller, 2700 watt, allows Reactor heated hose extended past 300 ft (91 m). Requires 200-230 volts at 15 amps
15F028	Band heater, 1000 watt, for 55 gal drum, 230 volt
206995	TSL, 1 qt (0.95 l)
206996	TSL, 1 gal (3.8 l)
246085	Data reporting kit
247827	Heater control module
247828	A, B hose heater power module
247838	Modular heater control to retrofit electric/hydraulic units
249634	Cold spray kit – includes Ultra-Lite gun and restrictor valve. For Reactor E-10 models only.
249635	Joint fill kit – includes Ultra-Lite gun and extension tip. For Reactor E-10 models only.
255148	Circulation valve kit – includes ISO and resin circulation valves
255149	Circulation valve – ISO only
255150	Circulation valve – resin only
256396	Reactor conversion kit 1-ph to 3-ph, 230V
256397	Reactor conversion kit 3-ph to 1-ph, 230V
GC1845	ISO Pump Lube System kit (<i>Guardian models only</i>)
261669	Fluid temperature sensor

Heated Hoses

Hoses, 2000 psi (138 bar, 13.8 MPa)



246045	1/4 in x 50 ft (6.3 mm x 15 m)
246046	3/8 in x 50 ft (9.5 mm x 15 m)
246047	1/2 in x 50 ft (12.7 mm x 15 m)
246048	1/4 in x 25 ft (6.3 mm x 7.6 m)
246049	3/8 in x 25 ft (9.5 mm x 7.6 m)
246074	1/4 in x 50 ft (6.3 mm x 15 m), no thermocouple wire
246075	3/8 in x 50 ft (9.5 mm x 15 m), no thermocouple wire
246076	1/2 in x 50 ft (12.7 mm x 15 m), no thermocouple wire
246678	3/8 in x 50 ft (9.5 mm x 15 m), with Scuffguard™
246050	Whip hose: 1/4 in x 10 ft (6.3 mm x 3 m) with Scuffguard
249586	Whip hose: 1/4 in x 3 ft (6.3 mm x 91 cm) with Scuffguard
255089	1/4 in x 3/8 in x 50 ft (6.3 mm x 9.5 mm x 15 m) with Scuffguard
256407	Unheated whip hose, 6 ft (1.8 m)
256549	3/8 in x 50 ft (9.5 mm x 15 m) no thermocouple wire, with Scuffguard

Hoses, 3500 psi (240 bar, 24.0 MPa)

246052	1/4 in x 50 ft (6.3 mm x 15 m)
246053	3/8 in x 50 ft (9.5 mm x 15 m)
246054	1/2 in x 50 ft (12.7 mm x 15 m)
246679	3/8 in x 50 ft (9.5 mm x 15 m), with Scuffguard
246055	Whip hose: 1/4 in x 10 ft (6.3 mm x 3 m), with Scuffguard
246056	Whip hose: 3/8 in x 10 ft (9.5 mm x 3 m), with Scuffguard
249588	3/8 in x 50 ft (9.5 mm x 15 m) no thermocouple wire
256548	1/2 in x 50 ft (12.7 mm x 15 m) with Scuffguard
261335	1/2 in x 50 ft (12.7 mm x 15 m) no thermocouple wire
247164	1/4 in x 3/8 in x 50 ft (6.3 mm x 9.5 mm x 15 m) with Scuffguard
261336	3/8 in x 1/2 in x 50 ft (9.5 mm x 12.7 mm x 15 m)
256626	Unheated whip hose, 6 ft (1.8 m)

Hose Accessories

246077	10 ft (3 m) braided polyester mesh Scuffguard
246078	50 ft (15 m) braided polyester mesh Scuffguard
246456	50 ft (15 m) polyethylene Scuffguard
246805	25 ft (7.6 m) braided polyester mesh Scuffguard
15B296	50 ft (15 m) Fluid Temperature Sensor (FTS) cable
15C626	25 ft (7.6 m) Fluid Temperature Sensor (FTS) cable
261669	Fluid temperature sensor
261821	Power-lock™ splice kit
15M312	Power-lock splice kit (20-pk) (enough for 10 hoses)

Supply Pumps and Agitators

Complete Supply Pump Systems

Includes the following: All air and fluid fittings, hoses for two pumps.

247955	Complete T1 (247956) supply pump system
246081	Complete T2 (246898) supply pump system
246655	Complete Triton® 308 (246677) supply pump system
246369	Complete Husky™ 515 (246481) supply pump system
246375	Complete Husky 716 (246482) supply pump system
246376	Complete Husky 1050 (246676) supply pump system

Supply Pumps with Drum Riser Tube

256200	T1 2:1 ratio piston pump for higher viscosity materials, 360 psi max fluid psi, 2.5 gpm @ 100 cpm
295616	T2 2:1 ratio piston pump for higher viscosity materials, 405 psi max fluid psi, 5.0 gpm @ 100 cpm
246654	Triton 308 diaphragm pump, aluminum, 3/8 in fluid outlet, 115 psi max air inlet, 2.0 gpm @ 60 cpm, 1.7 cfm per gpm
246366	Husky 515 diaphragm pump, acetal bolted design, 100 psi max air inlet, 7.5 gpm @ 60 cpm, 3 cfm per gpm
246367	Husky 716 diaphragm pump, aluminum clamped design, 100 psi max air inlet, 7.5 gpm @ 60 cpm, 3 cfm per gpm
246368	Husky 1050 diaphragm pump for trailer mounts – aluminum, bolted, wall mount, 125 psi max air inlet, 9 gpm @ 60 cpm
248825	5:1 Monark® drum pump, for high viscosity materials, 900 psi max fluid psi, 10 ft (3 m) hose, 3/4 npt (m), air regulator, manual 310863

Two Supply Pumps with Fluid Plumbing

247956	T1 pumps with supply hoses
246898	T2 pumps with supply hoses
246677	Triton 308 (246654), 10 ft x 3/4 in (3 m x 19 mm) supply hose
246481	Husky 515 (246366), 10 ft x 3/4 in (3 m x 19 mm) supply hose
246482	Husky 716 (246367), 10 ft x 3/4 in (3 m x 19 mm) supply hose
246676	Husky 1050 (246368), 10 ft x 3/4 in (3 m x 19 mm) supply hose, 6 ft x 3/4 in (1.8 m x 19 mm) suction hose

Supply Pump Accessories

246419	55 gal (208 l) feed pump tube with inlet ball check
246477	3/4 in (19 mm) bung return tube with air dryer port
246483	Air distribution kit, 120 psi (8.4 bar, 0.84 MPa) for two feed pumps and a Fusion gun
247616	Desiccant dryer kit
246978	Reactor manifold circulation kit with return tubes, return fluid lines and dryers
15C381	Desiccant replacement

Agitators

224854	Twistork CS, air-operated, 1-1/2 HP, 37.3 in (0.9 m) length
235534	Twistork SST, air-operated, 1-1/2 HP, 37.3 in (0.9 m) length
236629	Twistork SST, air-operated with built-in return tube, 3/4 HP, 47.5 in (1.2 m) in length
248824	Twistork CS, air-operated (224854), 1-1/2 HP, 37.3 in (0.9 m) with air hose
24C728	Expanding blade mixer, low viscosity, up to 1000 centipoise
24C729	Expanding blade mixer, high-viscosity, up to 2000 centipoise

Liquid-Purge Guns

Fusion CS Gun, Round

CS20RD	RD2020 (000) round mix chamber (.020 orifice size)
CS00RD	RD0000 (00) round mix chamber (.029 orifice size)
CS01RD	RD0101 (01) round mix chamber (.042 orifice size)
CS02RD	RD0202 (02) round mix chamber (.052 orifice size)
CS03RD	RD0303 (03) round mix chamber (.060 orifice size)

Fusion CS Gun, Wide Round

CS22WD	WD2222 wide mix chamber (.022 orifice size)
CS00WD	WD0000 wide mix chamber (.028 orifice size)
CS01WD	WD0101 wide mix chamber (.039 orifice size)
CS02WD	WD0202 wide mix chamber (.046 orifice size)
CS03WD	WD0303 wide mix chamber (.057 orifice size)



Fusion CS Gun, Flat

CS20F1	FL2020 mix chamber with FT0424 flat tip (.020 orifice size)
CS20F2	FL2020 mix chamber with FT0438 flat tip (.020 orifice size)
CS00F1	FL0000 mix chamber with FT0424 flat tip (.029 orifice size)
CS00F2	FL0000 mix chamber with FT0438 flat tip (.029 orifice size)
CS00F3	FL0000 mix chamber with FT0624 flat tip (.029 orifice size)
CS00F4	FL0000 mix chamber with FT0638 flat tip (.029 orifice size)
CS00F5	FL0000 mix chamber with FT0838 flat tip (.029 orifice size)
CS00F6	FL0000 mix chamber with FT0848 flat tip (.029 orifice size)
CS01F1	FL0101 mix chamber with FT0424 flat tip (.042 orifice size)
CS01F2	FL0101 mix chamber with FT0438 flat tip (.042 orifice size)
CS01F3	FL0101 mix chamber with FT0624 flat tip (.042 orifice size)
CS01F4	FL0101 mix chamber with FT0638 flat tip (.042 orifice size)
CS01F5	FL0101 mix chamber with FT0838 flat tip (.042 orifice size)
CS01F6	FL0101 mix chamber with FT0848 flat tip (.042 orifice size)
CS02F1	FL0202 mix chamber with FT0424 flat tip (.052 orifice size)
CS02F2	FL0202 mix chamber with FT0438 flat tip (.052 orifice size)
CS02F3	FL0202 mix chamber with FT0624 flat tip (.052 orifice size)
CS02F4	FL0202 mix chamber with FT0638 flat tip (.052 orifice size)
CS02F5	FL0202 mix chamber with FT0838 flat tip (.052 orifice size)
CS02F6	FL0202 mix chamber with FT0848 flat tip (.052 orifice size)

Fusion CS Parts and Accessories

256385	ClearShot Liquid Cartridges - pack of 25
256386	ClearShot Liquid Cartridges - pack of 50
256387	ClearShot Liquid Cartridges - pack of 100
117773	Fusion grease (248280 - pack of 10)
118665	Fusion lube (248279 - pack of 10)
246357	Gun filter, 40 mesh - pack of 10
246358	Gun filter, 60 mesh - pack of 10
246359	Gun filter, 80 mesh - pack of 10
248132	Fluid housing O-ring, large - pack of 6
248648	Fluid housing O-ring, mix chamber - pack of 6
256414	Cover retainer kit - pack of 5
256415	Front cover, round kit - pack of 5
256416	Front cover, tip kit - pack of 5
256454	Air piston kit
256455	Spool valve kit
256456	Variable flow kit
256457	Front end replacement kit
256459	A Side valve kit
256460	B Side valve kit
256461	Fluid head checks kit
256462	Hose manifold checks kit
256463	Side seal housings kit
256464	Side seals kit
256466	Hose manifold kit
256465	Polycarbally seals kit, pack of 2
256469	Hose manifold check O-rings kit
256470	Air piston O-ring kit
256471	Fluid head O-ring kit
256472	Back cap O-ring kit
256467	Side seal O-rings - pack of 6
256468	Side seal housing O-rings - pack of 6
256489	Polycarbally seals kit, pack of 20
256490	Complete O-rings repair kit
256510	Fusion CS solvent flush kit
256526	Fusion CS gun clean out drill kit
256566	Fusion CS recirc manifold kit
256567	Tip retainer kit
256569	Fusion CS TP100 tip kit
256570	Fusion CS stud wall tip kit
256640	O-ring, fluid head checks kit - pack of 6
256641	Fusion CS flush manifold kit
258996	CS Adapter Block, used with AP hose manifold

256642	Inlet cover kit
256650	TP100 seals - pack of 5
256651	Stud wall tip seals - pack of 5
256771	Check valve O-ring, radial - pack of 6
256772	Air piston O-ring, small - pack of 6
256773	Fluid housing O-ring, small - pack of 6
256774	Variable flow O-ring - pack of 6
256775	Air piston O-ring, large - pack of 6
256923	Side seal springs - pack of 10
256977	Studwall retainer kit / TP 100
256978	Studwall housing kit / TP 100
257142	Polycarbally side seal housing kit
257419	Check valve spring - pack of 10
257420	Check ball - pack of 10
257421	Check valve retainer - pack of 10
257422	Check valve kit, Fusion CS (ISO)
257423	Check valve kit, Fusion CS (resin)
257424	Dosing piston with O-rings
257426	Variable flow O-ring kit - pack of 6
257427	Check valve housing (ISO) - pack of 10
257428	Check valve housing (resin) - pack of 10

Fusion CS Mix Chamber Kits (Includes clean-out tools)

FL2020	Fusion CS 2020 flat mix chamber kit
FL0000	Fusion CS 2929 flat mix chamber kit
FL0101	Fusion CS 4242 flat mix chamber kit
FL0202	Fusion CS 5252 flat mix chamber kit
RD2020	Fusion CS 2020 round mix chamber kit
RD0000	Fusion CS 2929 round mix chamber kit
RD0101	Fusion CS 4242 round mix chamber kit
RD0202	Fusion CS 5252 round mix chamber kit
RD0303	Fusion CS 6060 round mix chamber kit
WD2222	Fusion CS 2222 wide mix chamber kit
WD0000	Fusion CS 2828 wide mix chamber kit
WD0101	Fusion CS 3939 wide mix chamber kit
WD0202	Fusion CS 4646 wide mix chamber kit
WD0303	Fusion CS 5757 wide mix chamber kit

Air-Purge Guns



Fusion Air-Purge Guns, Round

246099	AR2020 (000) mix chamber (0.020 orifice size)
246100	AR2929 (00) mix chamber (0.029 orifice size)
246101	AR4242 (01) mix chamber (0.042 orifice size)
246102	AR5252 (02) mix chamber (0.052 orifice size)
246103	AR6060 (03) mix chamber (0.060 orifice size)
246104	AR7070 (04) mix chamber (0.070 orifice size)
246105	AR8686 (05) mix chamber (0.086 orifice size)
248617	AR3737 mix chamber, sized between AR2929 and AR4242
24D581	AW2828 (00) wide round pattern
249529	AW3939 (01) wide round pattern
249530	AW4646 (02) wide round pattern
248408	Adhesive/spatter gun for fleeceback roofing systems
249525	Stud wall gun w/AF4242 and FTM979
249526	Stud wall gun w/AF5252 and FTM979

Fusion Air-Purge Mix Chambers, Round (includes clean-out tools)

AR2020	(000) mix chamber (0.020 orifice size)
AR2929	(00) mix chamber (0.029 orifice size)
AR3737	Mix chamber with (between 0.029 and 0.042 orifice size)
AR4242	(01) mix chamber (0.042 orifice size)
AR5252	(02) mix chamber (0.052 orifice size)
AR6060	(03) mix chamber (0.060 orifice size)
AR7070	(04) mix chamber (0.070 orifice size)
AR8686	(05) mix chamber (0.086 orifice size)

Ordering Information

To get genuine Graco accessories, see your nearest Graco distributor, or call Graco at 877-844-7226



Air-Purge Guns continued

Fusion Air-Purge Mix Chambers, Wide Round (Includes clean-out tools)

AW2222	50% wider pattern, compares to AR2020
AW2828	50% wider pattern, compares to AR2929
AW3333	50% wider pattern, compares to AR3737
AW3939	50% wider pattern, compares to AR4242
AW4646	50% wider pattern, compares to AR5252
AW5757	50% wider pattern, compares to AR6060
AW6464	50% wider pattern, compares to AR7070
AW8282	50% wider pattern, compares to AR8686

Fusion Air-Purge Gun, Flat

247101	AF2020 mix chamber with FT0424 flat tip
247102	AF2020 mix chamber with FT0438 flat tip
247103	AF2020 mix chamber with FT0624 flat tip
247104	AF2020 mix chamber with FT0638 flat tip
247107	AF2020 mix chamber with FT0838 flat tip
247108	AF2020 mix chamber with FT0848 flat tip
247111	AF2929 mix chamber with FT0424 flat tip
247112	AF2929 mix chamber with FT0438 flat tip
247113	AF2929 mix chamber with FT0624 flat tip
247114	AF2929 mix chamber with FT0638 flat tip
247117	AF2929 mix chamber with FT0838 flat tip
247118	AF2929 mix chamber with FT0848 flat tip
247121	AF4242 mix chamber with FT0424 flat tip
247122	AF4242 mix chamber with FT0438 flat tip
247123	AF4242 mix chamber with FT0624 flat tip
247124	AF4242 mix chamber with FT0638 flat tip
247127	AF4242 mix chamber with FT0838 flat tip
247128	AF4242 mix chamber with FT0848 flat tip
247131	AF5252 mix chamber with FT0424 flat tip
247132	AF5252 mix chamber with FT0438 flat tip
247133	AF5252 mix chamber with FT0624 flat tip
247134	AF5252 mix chamber with FT0638 flat tip
247137	AF5252 mix chamber with FT0838 flat tip
247138	AF5252 mix chamber with FT0848 flat tip

Fusion Air-Purge Mix Chambers, Flat (includes clean-out tool and O-ring)

AF2020	(000) mix chamber	AF2033	Off-ratio mix chamber
AF2929	(00) mix chamber	AF2942	Off-ratio mix chamber
AF4242	(01) mix chamber		
AF5252	(02) mix chamber		

Fusion Air-Purge Tips, Flat

FT0424	Low fluid flow, 8 to 10 in tip pattern
FT0438	Medium fluid flow, 8 to 10 in pattern
FT0624	Low fluid flow, 12 to 14 in tip pattern
FT0638	Medium fluid flow, 12 to 14 in tip pattern
FT0838	Medium fluid flow, 16 to 18 in pattern
FT0848	High fluid flow, 16 to 18 in pattern

Fusion Air-Purge with PolyCarballoy Options

255201	AP Fusion w/ PolyCarballoy side seal - AR4242(01) mix chamber
255202	AP Fusion w/ PolyCarballoy side seal - AR5252(02) mix chamber
249990	PolyCarballoy side seals, pack of 2
277298	PolyCarballoy side seals, pack of 50

Fusion Air-Purge Parts and Accessories

15B772	1/8 in (3.18 mm) air hose, 18 in (.46 m) long, use to attach gun to whip hose
15D234	Flat tip cleanout tool
15B210	Air cap, round pattern, for Fusion Air-Purge Gun
15B801	Air cap, flat pattern, for Fusion Air-Purge Gun
15B565	Ball valve
15B817	Gun flush manifold block
15D546	Fusion gun cleaning kit
117509	1/4 npt male quick disconnect, air
117510	1/4 npt female quick disconnect, air
117661	Pin vise, double-ended pin vise, with reversible chucks

117773	Fusion grease, 3 oz cartridge (248280 – pack of 10)
117792	Fusion grease gun
118665	Fusion lube, 4 oz tube (248279 – pack of 10)
119386	Drill bit kit, 20 piece, #61 - #81
244914	Air-Purge gun cover kit, pack of 10
246012	Fluid manifold assembly
246347	Side seal O-ring kit, includes (6) O-rings for both cartridges
246348	Side seal kit, includes (2) side seals with O-rings
246349	A (ISO) cartridge assembly, A-side, SST, seal and O-rings
246350	B (Poly) cartridge assembly, B-side, SST, seal and O-rings
246351	Check valve seal repair kit
246352	Check valve assembly, B (Poly)
246354	O-ring, clean off air, pack of 6
246355	Gun seal repair kit, includes all necessary O-rings for the entire gun assembly
246356	Fluid manifold valve repair kit
246357	Gun filter, 40 mesh, pack of 10
246358	Gun filter, 60 mesh, pack of 10
246359	Gun filter, 80 mesh, pack of 10
246360	Flat tip sealing O-ring kit, pack of 3
246361	Quick change front half spray head kit, includes entire spray head assembly less mix chamber. Order mix chamber separately.
246731	Check valve assembly, A (ISO)
246944	Manifold conversion kit; converts Fusion manifold to fit a GX-7 gun. Fusion manifold 246012 not included.
246945	Manifold conversion kit; converts GX-7 manifold to fit a Fusion gun
248129	Check valve O-ring, radial, pack of 6
248130	Side seal housing O-ring kit, pack of 6
248132	O-ring, fluid housing, pack of 6
248133	Check valve O-ring, face, pack of 6
248139	Solvent flush kit, 1 qt (.95 l) pressurized container for solvent flushing gun before service
248229	5 gal Fusion Gun flush system
248279	Fusion lube for lubricating threads, O-rings, components, pack of 10
248280	Fusion grease, pack of 10
248414	Adhesive/spatter kit, converts Fusion Air-Purge to adhesive/spatter gun
248415	Tip for adhesive/spatter gun
248528	Fusion Air-Purge pour adapter kit

Fusion Air-Purge Extension Tip Kits

248010	Extension tip kit for AR2020/AF2929 mix chamber
248011	Extension tip kit for AR2929/AF2929 mix chamber
248012	Extension tip kit for AR4242/AF4242 mix chamber
248013	Extension tip kit for AR5252/AF5252 mix chamber
248014	Extension tip kit for AR2020/AF2929 mix chamber
248015	Extension tip kit for AR2929/AF2929 mix chamber
248016	Extension tip kit for AR4242/AF4242 mix chamber
248017	Extension tip kit for AR5252/AF5252 mix chamber
248020	Extension tip air cap kit
248018	Flat extension tip seal kit
248019	Round extension tip seal kit
249421	Fusion stud wall kit
24C358	Fusion TP 100 tip kit

P2 Guns

GCP2R0	Probler 2 Gun Assembly
GCP2R1	Probler 2 Gun Assembly
GCP2R2	Probler 2 Gun Assembly
GCP2R3	Probler 2 Gun Assembly
GCP2R4	Probler 2 Gun Assembly
GCP2R5	Probler 2 Gun Assembly
GCP2RA	Probler 2 Gun Assembly

P2 Elite Guns

GCP3R0	Probler P2 Elite Gun Assembly
GCP3R1	Probler P2 Elite Gun Assembly
GCP3R2	Probler P2 Elite Gun Assembly
GCP3R3	Probler P2 Elite Gun Assembly
GCP3R4	Probler P2 Elite Gun Assembly
GCP3R5	Probler P2 Elite Gun Assembly
GCP3RA	Probler P2 Elite Gun Assembly

P2 Auto Guns

GCP4R0	Probler 2 Automatic Gun
GCP4R1	Probler 2 Automatic Gun
GCP4R2	Probler 2 Automatic Gun
GCP4R3	Probler 2 Automatic Gun
GCP4R4	Probler 2 Automatic Gun
GCP4R5	Probler 2 Automatic Gun
GCP4RA	Probler 2 Automatic Gun

P2 Spare Parts and Accessories

GC1703	P2 recirculation kit
GC1892	P2 Elite conversion kit
GC1937	P2 standard repair kit
GC1938	P2 flat spray kit
GC1946	Side seal kit
GC1947	P2 00-03 gun hardware kit
GC1948	P2 AA gun hardware kit
GC1949	P2 04-05 gun hardware kit
GC1950	Premium repair kit
GC1952	P2 0.059 jet nozzle
GC1953	P2 0.07 jet nozzle
GC1954	P2 pour cap
GC1955	P2 LP/HP static mixer adapter
GC1956	P2 static mixer assembly (non-nucleated)
GC1957	P2 16-in stud wall spray tip
GC1958	P2 24-in stud wall spray tip
GC1959	P2 delay plug
GC1966	P2 delayed air purge gun assembly
GC1967	P2 dispense counter assembly
GC1968	P2 stroke signal tee counter
GC2494	P2 seal kit
GC2495	P2 seal housing kit
GC2496	P2 40 mesh filter kit
GC2497	P2 100 mesh filter kit
GC2498	P2 side seal kit
GC2499	P2 handle kit
GC2500	P2 round 00 mix chamber kit
GC2501	P2 round 01 mix chamber kit
GC2502	P2 round 02 mix chamber kit
GC2503	P2 round 03 mix chamber kit
GC2504	P2 round 04 mix chamber kit
GC2505	P2 round 05 mix chamber kit
GC250A	P2 round AA mix chamber kit
GC2510	Mix chamber 00 insert kit
GC2511	Mix chamber 01 insert kit
GC2512	Mix chamber 02 insert kit
GC2513	Mix chamber 03 insert kit
GC2514	Mix chamber 04 insert kit
GC2515	Mix chamber 05 insert kit
GC251A	Mix chamber AA insert kit
257988	P2 Elite chopper attachment, B-410
257989	P2 Elite chopper attachment, B-510

Gap Pro Gun

295550	GAP Pro flat package #00 chamber
295551	GAP Pro flat package #01 chamber
295552	GAP Pro flat package #02 chamber
295553	GAP Pro flat package #03 chamber
295554	GAP Pro flat package #04 chamber
295557	GAP Pro round package #00 chamber
295558	GAP Pro round #00 Recirc
295559	GAP Pro round package #01 chamber
295560	GAP Pro round package #02 chamber
295561	GAP Pro round package #03 chamber
295562	GAP Pro round package #04 chamber

Gap Pro Gun Parts and Accessories

261293	TP100 tip kit
296348	TP100 tip
296840	Mix chamber GAP Pro flat-00
296841	Mix chamber GAP Pro flat-01
296842	Mix chamber GAP Pro flat-02
296843	Mix chamber GAP Pro flat-03
296844	Mix chamber GAP Pro flat-04
296845	Mix chamber GAP Pro flat-05
296846	Mix chamber GAP Pro round-00
296847	Mix chamber GAP Pro round-01
296848	Mix chamber GAP Pro round-02
296849	Mix chamber GAP Pro round-03
296850	Mix chamber GAP Pro round-04
296851	Mix chamber GAP Pro round-05
296942	Screen screw seal kit, pack of 2
296945	Air seal, small mix chamber
296946	Air seal, large mix chamber
296953	Check valve kit
296956	Side seal kit, pack of 2
296970	Manual valve assembly
296939	80 screen mesh kit, pack of 10



Mechanical-Purge Guns

Fusion Mechanical-Purge Guns, DI, Flat

247050	Fusion MP direct impingement, flat pattern XF1313, FTM317
247051	Fusion MP direct impingement, flat pattern XF1313, FTM424
247057	Fusion MP direct impingement, flat pattern XF1818, FTM317
247058	Fusion MP direct impingement, flat pattern XF1818, FTM424
247061	Fusion MP direct impingement, flat pattern XF2323, FTM424
247062	Fusion MP direct impingement, flat pattern XF2323, FTM438
247063	Fusion MP direct impingement, flat pattern XF2323, FTM624
247065	Fusion MP direct impingement, flat pattern XF2929, FTM424
247066	Fusion MP direct impingement, flat pattern XF2929, FTM438
247067	Fusion MP direct impingement, flat pattern XF2929, FTM624
247073	Fusion MP direct impingement, flat pattern XF3535, FTM438
247074	Fusion MP direct impingement, flat pattern XF3535, FTM624
247075	Fusion MP direct impingement, flat pattern XF3535, FTM638
247081	Fusion MP direct impingement, flat pattern XF4747, FTM624
247082	Fusion MP direct impingement, flat pattern XF4747, FTM638
247083	Fusion MP direct impingement, flat pattern XF4747, FTM838
247089	Fusion MP direct impingement, flat pattern XF5757, FTM638
247090	Fusion MP direct impingement, flat pattern XF5757, FTM838
247091	Fusion MP direct impingement, flat pattern XF5757, FTM848
247163	Fusion MP direct impingement, flat pattern XF2332, FTM438

Fusion Mechanical-Purge Guns, Standard, Flat

247257	Fusion MP standard, flat pattern MF1818, FTM317
247258	Fusion MP standard, flat pattern MF1818, FTM424
247265	Fusion MP standard, flat pattern MF2929, FTM424
247266	Fusion MP standard, flat pattern MF2929, FTM438
247267	Fusion MP standard, flat pattern MF2929, FTM624
247273	Fusion MP standard, flat pattern MF3535, FTM438
247274	Fusion MP standard, flat pattern MF3535, FTM624
247275	Fusion MP standard, flat pattern MF3535, FTM638
247281	Fusion MP standard, flat pattern MF4747, FTM624
247282	Fusion MP standard, flat pattern MF4747, FTM638
247283	Fusion MP standard, flat pattern MF4747, FTM838
247289	Fusion MP standard, flat pattern MF5757, FTM638
247290	Fusion MP standard, flat pattern MF5757, FTM838
247291	Fusion MP standard, flat pattern MF5757, FTM848

Ordering Information

To get genuine Graco accessories, see your nearest Graco distributor, or call Graco at 877-844-7226



Mechanical-Purge Guns continued

Fusion Mechanical-Purge Guns, DI, Round

247003	Fusion MP direct impingement, round pattern XR2323, RTM040
247006	Fusion MP direct impingement, round pattern XR2929, RTM030
247007	Fusion MP direct impingement, round pattern XR2929, RTM040
247011	Fusion MP direct impingement, round pattern XR3535, RTM030
247012	Fusion MP direct impingement, round pattern XR3535, RTM040
247013	Fusion MP direct impingement, round pattern XR3535, RTM055
247018	Fusion MP direct impingement, round pattern XR4747, RTM040
247019	Fusion MP direct impingement, round pattern XR4747, RTM055
247025	Fusion MP direct impingement, round pattern XR5757, RTM055
247026	Fusion MP direct impingement, round pattern XR5757, RTM070

Fusion Mechanical-Purge Guns, Standard, Round

247211	Fusion MP standard, round pattern MR3535, RTM030
247212	Fusion MP standard, round pattern MR3535, RTM040
247213	Fusion MP standard, round pattern MR3535, RTM055
247218	Fusion MP standard, round pattern MR4747, RTM040
247219	Fusion MP standard, round pattern MR4747, RTM055
247225	Fusion MP standard, round pattern MR5757, RTM055
247226	Fusion MP standard, round pattern MR5757, RTM070
247231	Fusion MP standard, round pattern MR6666, RTM070
247232	Fusion MP standard, round pattern MR6666, RTM080
247233	Fusion MP standard, round pattern MR6666, RTM090
247239	Fusion MP standard, round pattern MR8282, RTM090
247240	Fusion MP standard, round pattern MR8282, RTM100
247245	Fusion MP standard, round pattern MR9494, RTM100
247246	Fusion MP standard, round pattern MR9494, RTM110

Fusion Mechanical-Purge Mix Modules

MF1818	Standard mix module, flat
MF2929	Standard mix module, flat
MF3535	Standard mix module, flat
MF4747	Standard mix module, flat
MF5757	Standard mix module, flat
MR3535	Standard mix module, round
MR4747	Standard mix module, round
MR5757	Standard mix module, round
MR6666	Standard mix module, round
MR8282	Standard mix module, round
MR9494	Standard mix module, round
XF1313	Direct impingement mix module, flat
XF1318	Direct impingement mix module, flat
XF1818	Direct impingement mix module, flat
XF1824	Direct impingement mix module, flat
XF2323	Direct impingement mix module, flat
XF2332	Direct impingement mix module, flat
XF2929	Direct impingement mix module, flat
XF3535	Direct impingement mix module, flat
XF4747	Direct impingement mix module, flat
XF5757	Direct impingement mix module, flat
XR2323	Direct impingement mix module, flat
XR2929	Direct impingement mix module, round
XR3535	Direct impingement mix module, round
XR4747	Direct impingement mix module, round
XR5757	Direct impingement mix module, round

Fusion Mechanical-Purge Round Tips

RTM024	Kit, round tip, mechanical-purge
RTM030	Kit, round tip, mechanical-purge
RTM040	Kit, round tip, mechanical-purge
RTM055	Kit, round tip, mechanical-purge
RTM070	Kit, round tip, mechanical-purge
RTM080	Kit, round tip, mechanical-purge
RTM090	Kit, round tip, mechanical-purge
RTM100	Kit, round tip, mechanical-purge
RTM110	Kit, round tip, mechanical-purge

Fusion Mechanical-Purge Flat Tips

FTM317	Kit, flat tip, mechanical-purge, 6 in (152 mm) pattern, very low flow
FTM424	Kit, flat tip, mechanical-purge, 8 in (203 mm) pattern, low flow
FTM438	Kit, flat tip, mechanical-purge, 8 in (203 mm) pattern, medium flow
FTM624	Kit, flat tip, mechanical-purge, 12 in (305 mm) pattern, low flow
FTM638	Kit, flat tip, mechanical-purge, 12 in (305 mm) pattern, medium flow
FTM838	Kit, flat tip, mechanical-purge, 16 in (406 mm) pattern, medium flow
FTM848	Kit, flat tip, mechanical-purge, 16 in (406 mm) pattern, high flow

Fusion Mechanical-Purge Parts and Accessories

244915	Mechanical-Purge gun cover kit, pack of 10
248603	Kit converts Fusion MP gun to Solvent-Purge
248642	Static mixer assembly for Solvent-Purge Gun, 3 in (76 mm)
248682	Fusion Mechanical pour adapter kit
15D546	Fusion gun cleaning kit
119386	Drill bit kit, 20-piece, #61-#81
248000	Kit, complete O-ring, Fusion MP
248001	Kit, purge rod
248003	Kit, front/rear packing, pack of 4

Fusion Specialty Guns

248408	Fusion AP spatter/adhesive manual gun
248597	Manual Fusion solvent-purge gun

Automatic Fusion (All Auto Fusion kits require 4-way solenoid valves)

115807	4-way solenoid valve, 24 volt DC
248376	Automatic Fusion AP, round, AR2929
248377	Automatic Fusion AP, round, AR4242
248378	Automatic Fusion AP, round, AR5252
248379	Automatic Fusion AP, round, AR6060
248380	Automatic Fusion AP, flat, AF2020, FT0424
248381	Automatic Fusion AP, flat, AF2929, FT0438
248382	Automatic Fusion MP, round, direct impingement, XR2929, RTM040
248383	Automatic Fusion MP, round, direct impingement, XR3535, RTM040
248384	Automatic Fusion MP, flat, direct impingement, XF1313, FTM317
248385	Automatic Fusion MP, flat, direct impingement, XF1818, FTM424
248386	Automatic Fusion MP, round, MR3535, RTM040
248387	Automatic Fusion MP, round, MR5757, RTM0702
248647	Auto Fusion - Solvent-Purge

GX-7 Guns

295542	GX-7 1/90 Gun
295543	GX-7 10/210 Gun
295544	GX-7 3/70 Gun
295545	GX-7 5/70 Gun
295541	GX-7 DI 4/213 Gun
295540	GX-7-400 Gun

GX-7, GX-7-DI Tips and Accessories

296128	Coupling block gasket, pack of 2
296692	Valving rod, 125
296693	Screen screw seal kit, pack of 2
296694	Round tip 100
296695	Round tip 110
296697	Round tip 125
256388	Single piece valving rod

296698	Fan tip 202
296700	Fan tip 204
296701	Fan tip 206
296702	Fan tip 208
296703	Fan tip 209
296704	Fan tip 210
296705	Fan tip 212
296706	Fan tip 213
296707	Fan tip 215
296708	Round tip 40
296709	Round tip 46
296710	Round tip 70
296711	Round tip 80
296712	Round tip 90
296715	Round tip 210
296716	Round tip 212
296717	Round tip 55, pack of 5
296718	Round tip 70, pack of 5
296719	Round tip 80, pack of 5
296720	Round tip 90, pack of 5
296722	Check valve kit, pack of 10
296723	Screen screw seal kit, pack of 2
296792	Screen screw seal kit, pack of 10
296724	80 mesh screen, package of 50
296829	Rear packing seal, pack of 5
296882	Fan tip 212.5 spec
296883	Fan tip 213.5 spec

GX-7 Mix Module Kits

296868	Module, A5 pour
296869	Module, A5 pour, pack of 12
296870	Module, A5-FS pour
296871	Module, A5-FS pour, pack of 12
296872	Module, A10 pour, pack of 12
296873	Module, A20 pour, pack of 12
296874	Module, A2 pour, pack of 12 (with 2 drills)
296875	Module, A2 pour
296876	Module, A3 pour
296885	Fan module, #402 round
296888	Fan module, #452 fan
296891	Fan module, #453 fan
296901	Ported module, #4
296903	Ported module, #5
296906	Round module, #10
296908	Round module, #1, pack of 12 (with 2 drills)
296909	Round module, #1
296910	Flat module, #12
296915	Round module, #16
296916	Round module, #2
296917	Round module, #22
296919	Round module, ported #3
296921	Round module, ported #4
296923	Round module, ported #5
296924	Round module, ported #53
296925	Fan module, ported #7 flat
296970	Manual valve
296978	Front packing
295868	PCD retainer O-ring

GX-7 DI Mix Module Kits

296900	Fan module #2
296901	Fan module #4
296903	Fan module #5

GX-7 400 Mix Module Kits

296885	Round module 402
296884	Round module 402, pack of 12
296859	Fan module 451
296860	Fan module 451, pack of 12
296888	Fan module 452
296887	Fan module 452, pack of 12
296891	Fan module 453
296890	Fan module 453, pack of 12

GX-7 400 Tip Kits

296858	Round 40
296852	Fan 210
296853	Fan 212
296854	Fan 212, pack of 5
296855	Fan 213
296856	Fan 213, pack of 5
296857	Fan 214
296892	Fan TOM

D-Gun

295530	D-Gun 55 mix chamber
295531	D-Gun 55 mix chamber recirc
295532	D-Gun 62 mix chamber
295533	D-Gun 70 mix chamber

D-Gun Parts and Accessories

296584	Mix chamber 46, L800
296585	Mix chamber 46, L-810
296586	Mix chamber 55, L
296587	Mix chamber 62, L
296588	Mix chamber 70, L
296594	Mix Chamber 46, N-800
296595	Mix chamber 46, N-810
296597	Mix chamber 55, N
296598	Mix chamber 62, N
296599	Mix chamber 70, N
296600	Mix chamber 78, N
296578	Valving Rod D-Gun 46
296579	Valving Rod D-Gun 55
296580	Valving Rod D-Gun 62
296581	Valving Rod D-Gun 70
296582	Valving Rod D-Gun 78
296634	Air Cap, D-Gun 55/62
296635	Air Cap, D-Gun 70/78
296838	Air Cap, D-Gun 46
296621	Screen screw seal kit, pack of 10
296622	80 mesh screen kit, pack of 10
296623	80 mesh screen kit, pack of 50
296611	Felt wiper kit, pack of 5
296125	Air valve repair kit
296725	Air cylinder seal kit
296614	Check Valve-A, D-Gun, pack of 10
296615	Check Valve-R, D-Gun, pack of 10

GX-8 Gun and Accessories

297898	GX-8 Gun, with 013 module
297832	GX-8 Gun with starter and service kit
295377	013 round module, pack of 5
295339	020 round tip
295428	024 round tip
295338	013 fan module
297192	201 fan tip
297841	202 fan tip



ABOUT GRACO

PROVEN QUALITY. LEADING TECHNOLOGY.

Founded in 1926, Graco is a world leader in fluid handling systems and components. Graco products move, measure, control, dispense and apply a wide range of fluids and viscous materials used in vehicle lubrication, commercial and industrial settings.

The company's success is based on its unwavering commitment to technical excellence, world-class manufacturing and unparalleled customer service. Working closely with qualified distributors, Graco offers systems, products and technology that set the quality standard in a wide range of fluid handling solutions. Graco provides equipment for spray finishing, protective coating, paint circulation, lubrication, and dispensing sealants and adhesives, along with power application equipment for the contractor industry. Graco's ongoing investment in fluid management and control will continue to provide innovative solutions to a diverse global market.

GRACO LOCATIONS

MAILING ADDRESS

P.O. Box 1441
Minneapolis, MN 55440-1441
Tel: 612-623-6000
Fax: 612-623-6777

AMERICAS

MINNESOTA

Worldwide Headquarters
Graco Inc.
88-11th Avenue N.E.
Minneapolis, MN 55413

EUROPE

BELGIUM

European Headquarters
Graco N.V.
Industrieterrein-Oude Bunders
Slakweidestraat 31
3630 Maasmechelen,
Belgium
Tel: 32 89 770 700
Fax: 32 89 770 777

ASIA PACIFIC

AUSTRALIA

Graco Australia Pty Ltd.
Suite 17, 2 Enterprise Drive
Bundoora, Victoria 3083
Australia
Tel: 61 3 9468 8500
Fax: 61 3 9468 8599

CHINA

Graco Hong Kong Ltd.
Shanghai Representative Office
Building 7
1029 Zhongshan Road South
Huangpu District
Shanghai 200011
The People's Republic of China
Tel: 86 21 649 50088
Fax: 86 21 649 50077

INDIA

Graco Hong Kong Ltd.
India Liaison Office
Room 443, Augusta Point
Regus Business Centre 53
Golf Course Road
Gurgaon, Haryana
India 122001
Tel: 91 124 435 4208
Fax: 91 124 435 4001

JAPAN

Graco K.K.
1-27-12 Hayabuchi
Tsuzuki-ku
Yokohama City, Japan 2240025
Tel: 81 45 593 7300
Fax: 81 45 593 7301

KOREA

Graco Korea Inc.
Shinhan Bank Building
4th Floor #1599
Gwanyang-Dong, Dongan-Ku,
Anyang-si, Korea 431-060
Tel: 82 31 476 9400
Fax: 82 31 476 9801

SALES/ DISTRIBUTION/ SERVICE

Call today for product information or to request a demonstration.

877-84GRACO (1-877-844-7226) or visit us at www.graco.com.

Graco Inc. is registered to I.S. EN ISO 9001

North America
Customer Service
800-328-0211
Fax 877-340-6427